

# **Kramer Electronics, Ltd.**

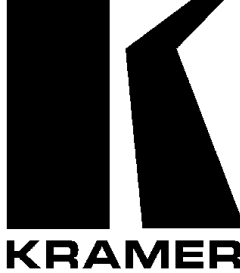

## **USER MANUAL**

### **Models:**

***VP-88ETH, 8x8 RGBH / Balanced Audio Matrix Switcher***

***VP-84ETH, 8x4 RGBH / Balanced Audio Matrix Switcher***

***VP-82ETH, 8x2 RGBH / Balanced Audio Matrix Switcher***

***VP-66ETH, 6x6 RGBH / Balanced Audio Matrix Switcher***

***VP-64ETH, 6x4 RGBH / Balanced Audio Matrix Switcher***

**Contents**

<b>1</b>	<b>Introduction</b>	<b>1</b>
<b>2</b>	<b>Getting Started</b>	<b>1</b>
<b>3</b>	<b>Overview</b>	<b>2</b>
<b>4</b>	<b>Your RGBH / Balanced Audio Matrix Switcher</b>	<b>3</b>
<b>5</b>	<b>Connecting the RGBH / Balanced Audio Matrix Switcher</b>	<b>11</b>
5.1	Connecting the Balanced/Unbalanced Stereo Audio Input/Output	13
5.2	Controlling via RS-232 (for example, using a PC)	14
5.3	Controlling via RS-485	15
5.4	Setting the ETHERNET Port and Utilities	16
5.4.1	Connecting the VP-88ETH Ethernet Port	16
5.4.2	Installing and Running the XPort Configuration Software	18
5.4.3	Configuring the ETHERNET Port	21
5.4.4	Using the Web Manager Page	21
5.4.5	Controlling a Machine using the Com Port Redirector	25
5.4.6	Using the Com Port Redirector	31
5.5	Setting the VP-88ETH Dipswitches	31
5.5.1	Setting the SELF ADDRESS Dipswitches	32
5.6	Setting the Reply Dipswitch	32
5.7	Setting the RS-232\RS-485 Dipswitch	32
<b>6</b>	<b>Operating Your VP-88ETH Machine</b>	<b>33</b>
6.1	Displaying the Unit Characteristics	33
6.2	Selecting and Connecting an Output and/or Input	33
6.3	Choosing the Audio-Follow-Video or Breakaway Option	34
6.3.1	Setting the Audio-Follow-Video Option	34
6.3.2	Setting the Breakaway Option	34
6.4	Confirming Settings	34
6.4.1	Toggling between the At Once and Confirm Modes	35
6.4.2	Confirming a Switching Action	35
6.5	Storing/Recalling Input/Output Configurations	36
6.5.1	Storing an Input/Output Configuration	36
6.5.2	Recalling an Input/Output Configuration	36
6.5.3	Deleting an Input/Output Configuration	36
6.6	Resetting the Machine	36
6.7	Using the TERM: 75Ω/TTL Buttons	37
<b>7</b>	<b>Controlling Several RGBHV / Balanced Audio Matrix Switchers</b>	<b>37</b>
7.1	Control Configuration via RS-232 and RS-485	37
7.2	Control Configuration via RS-485	39
7.3	Control Configuration via the ETHERNET Port	40
<b>8</b>	<b>Technical Specifications</b>	<b>41</b>
<b>9</b>	<b>Table of Hex Codes for the Master VP-88ETH</b>	<b>42</b>
<b>10</b>	<b>Communication Protocol</b>	<b>43</b>



## Figures

Figure 1: VP-88ETH 8x8 RGBHV / Balanced Audio Matrix Switcher	4
Figure 2: VP-84ETH 8x4 RGBHV / Balanced Audio Matrix Switcher	5
Figure 3: VP-82ETH 8x2 RGBHV / Balanced Audio Matrix Switcher	6
Figure 4: VP-66ETH 6x6 RGBHV / Balanced Audio Matrix Switcher	7
Figure 5: VP-64ETH 6x4 RGBHV / Balanced Audio Matrix Switcher	8
Figure 6: Connecting the VP-88ETH 8x8 RGBHV / Balanced Audio Matrix Switcher	12
Figure 7: Connecting the Balanced Stereo Audio Input/Output	13
Figure 8: Connecting the Unbalanced Stereo Audio Output	13
Figure 9: Connecting an Unbalanced Source to the Balanced Input	13
Figure 10: Connecting a PC without using a Null-modem Adapter	14
Figure 11: Controlling via RS-485 (for example, using an RC-3000)	15
Figure 12: Local Area Connection Properties Window	17
Figure 13: Internet Protocol (TCP/IP) Properties Window	17
Figure 14: XPort™ Installer Main Dialog Box	19
Figure 15: Device Found on the Network	19
Figure 16: IP Address Assignment Dialog Box	20
Figure 17: ETHERNET Port Web-Manager	21
Figure 18: Server Configuration in the Unit Configuration Window	22
Figure 19: Port Configuration in the Unit Configuration Window	23
Figure 20: Server Properties in the Unit Configuration Window	23
Figure 21: Serial Port Settings Window	24
Figure 22: Dedicated Connection Window	24
Figure 23: Flush Mode Input Buffer Window	24
Figure 24: Com Port Redirector Welcome Screen	25
Figure 25: Setup Complete Dialog Box	26
Figure 26: Com Port Redirector Configuration Window	26
Figure 27: Port Setup Window	27
Figure 28: IP Service Setup Dialog Box	28
Figure 29: Port Settings Window	29
Figure 30: Silent Mode Checked in the RDCfg Window	30
Figure 31: VP-88ETH Dipswitches	31
Figure 32: Control Configuration via RS-232 and RS-485	38
Figure 33: Control Configuration via RS-485	40

## Tables

Table 1: The RGBH / Balanced Audio Matrix Switcher Front Panel Features	9
Table 2: The RGBH / Balanced Audio Matrix Switcher Rear Panel Features	10
Table 3: Crossover Cable RJ-45 PINOUT	16
Table 4: Straight-through Cable RJ-45 PINOUT	18
Table 5: Web Manager Window Buttons	22
Table 6: Port Settings Description	29
Table 7: Dipswitch Settings	31
Table 8: MACHINE # Dipswitch Settings	32
Table 9: Technical Specifications of the RGBH / Balanced Audio Matrix Switchers	41
Table 10: Hex Codes for Switching the Master VP-88ETH	42
Table 11: Protocol Definitions	43

## 1 Introduction

Welcome to Kramer Electronics (since 1981): a world of unique, creative and affordable solutions to the infinite range of problems that confront the video, audio and presentation professional on a daily basis. In recent years, we have redesigned and upgraded most of our line, making the best even better! Our 350-plus different models now appear in 8 Groups<sup>1</sup>, which are clearly defined by function.

Congratulations on purchasing your Kramer *RGBH / Balanced Audio Matrix Switcher*<sup>2</sup>, which is ideal for presentation and production applications. The package includes the following items:

- **VP-88ETH/VP-84ETH/VP-82ETH/VP-66ETH/VP-64ETH** *RGBH / Balanced Audio Matrix Switcher*
- Power cord and Null-modem adapter
- Windows®-based Configuration Manager XPort software and Com Port Redirector
- Windows®-based Kramer control software<sup>3</sup>
- This user manual<sup>4</sup>

## 2 Getting Started

We recommend that you:

- Unpack the equipment carefully and save the original box and packaging materials for possible future shipment
- Review the contents of this user manual
- Use Kramer high performance high resolution cables<sup>5</sup>

---

1 GROUP 1: Distribution Amplifiers; GROUP 2: Video and Audio Switchers, Matrix Switchers and Controllers; GROUP 3: Video, Audio, VGA/XGA Processors; GROUP 4: Interfaces and Sync Processors; GROUP 5: Twisted Pair Interfaces; GROUP 6: Accessories and Rack Adapters; GROUP 7: Scan Converters and Scalers; and GROUP 8: Cables and Connectors

2 Available in the following models: VP-88ETH (an 8x8 model), VP-84ETH (an 8x4 model), VP-82ETH (an 8x2 model), VP-66ETH (a 6x6 model), and/or VP-64ETH (a 6x4 model)

3 Downloadable from our Web site at <http://www.kramerelectronics.com>

4 Download up-to-date Kramer user manuals from our Web site at <http://www.kramerelectronics.com>

5 The complete list of Kramer cables is on our Web site at <http://www.kramerelectronics.com>

### 3 Overview

The high performance **VP-88ETH/VP-84ETH/VP-82ETH/VP-66ETH/VP-64ETH** *RGBH / Balanced Audio Matrix Switcher* is designed for high-resolution computer graphics signals and balanced stereo audio signals. Each machine is a true matrix, routing any input to any or all outputs simultaneously.

In particular, the *RGBH / Balanced Audio Matrix Switcher*:

- Consists of three large bandwidth video channels, Red, Green and Blue (RGB) and two TTL (logic level) channels – Horizontal and Vertical sync
- Switches channels during the vertical interval, offering glitch free transitions when sources share a common reference sync
- Provides Audio breakaway, for switching audio independently from video
- Offers preset memory locations for quick access to common configurations
- Includes the TAKE button, which lets you place multiple switches in a queue and then activate them with one touch of this button
- Can be used for mixed applications such as Y/C and YUV simultaneously
- Includes an ETHERNET connection that supports easy dial-up and Internet system remote control (requiring only a dedicated IP address<sup>1</sup> and a modem in the remote location) whether it is a stand-alone PC or a LAN<sup>2</sup> system

Control the **VP-88ETH/VP-84ETH/VP-82ETH/VP-66ETH/VP-64ETH** using the front panel buttons, or remotely via:

- RS-485 or RS-232 serial commands transmitted by a touch screen system, PC, or other serial controller
- ETHERNET
- The Kramer **RC-IR1** Infra-Red Remote Control Transmitter<sup>3</sup>

The **VP-88ETH/VP-84ETH/VP-82ETH/VP-66ETH/VP-64ETH** is dependable, rugged and fits into three vertical spaces (3U) of a standard 19" rack.

---

<sup>1</sup> IP Address is a 32-binary digit number that identifies each sender or receiver (within a network via a particular server or workstation) of data (HTML pages or e-mails) that is sent in packets across the Internet. Every device connected to an IP network must have a unique IP address. This address is used to reference the specific unit

<sup>2</sup> LAN is Local Area Network

<sup>3</sup> Previously known as the IR-1/IR-1-01

To achieve the best performance:

- Connect only good quality connection cables, thus avoiding interference, deterioration in signal quality due to poor matching, and elevated noise-levels (often associated with low quality cables)
- Avoid interference from neighboring electrical appliances and position your Kramer **VP-88ETH/VP-84ETH/VP-82ETH/VP-66ETH/VP-64ETH** away from moisture, excessive sunlight and dust

## 4 Your RGBH / Balanced Audio Matrix Switcher

This section describes each switcher as follows:

- **VP-88ETH** (see Figure 1)
- **VP-84ETH** (see Figure 2)
- **VP-82ETH** (see Figure 3)
- **VP-66ETH** (see Figure 4)
- **VP-64ETH** (see Figure 5)

Table 1 and Table 2 define the front and rear panels of the machines.

Your RGBH / Balanced Audio Matrix Switcher

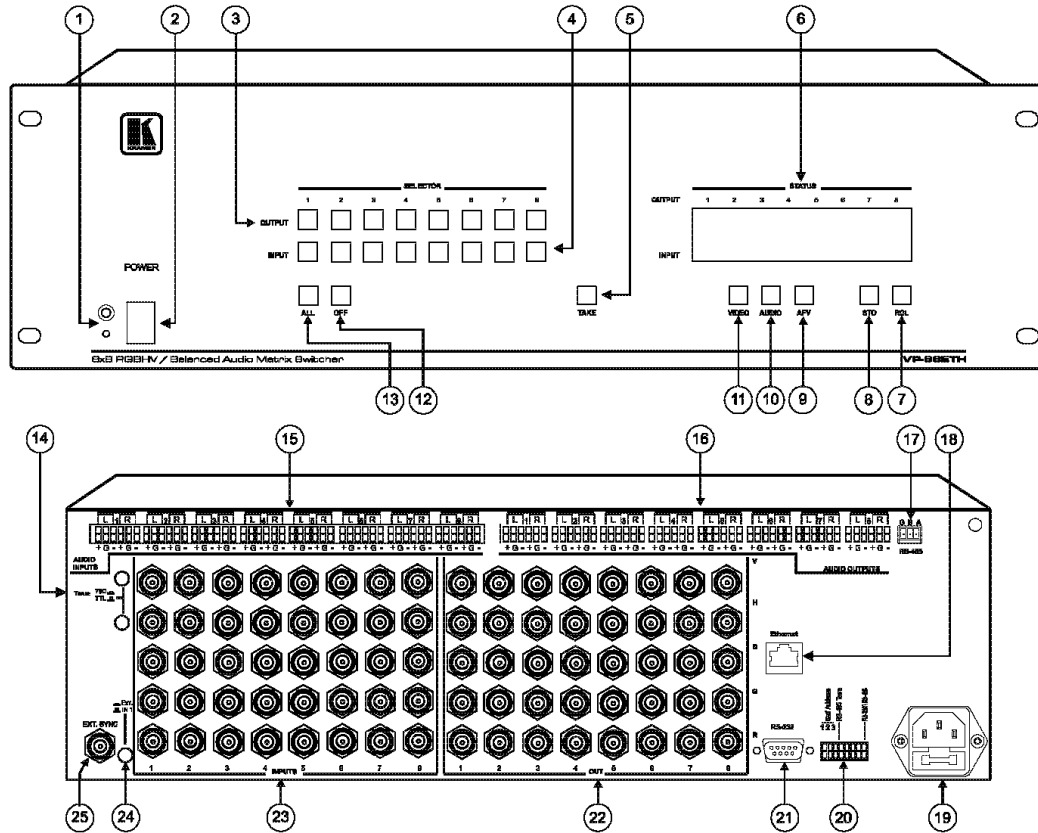

Figure 1: VP-88ETH 8x8 RGBHV / Balanced Audio Matrix Switcher

# Your RGBHV / Balanced Audio Matrix Switcher

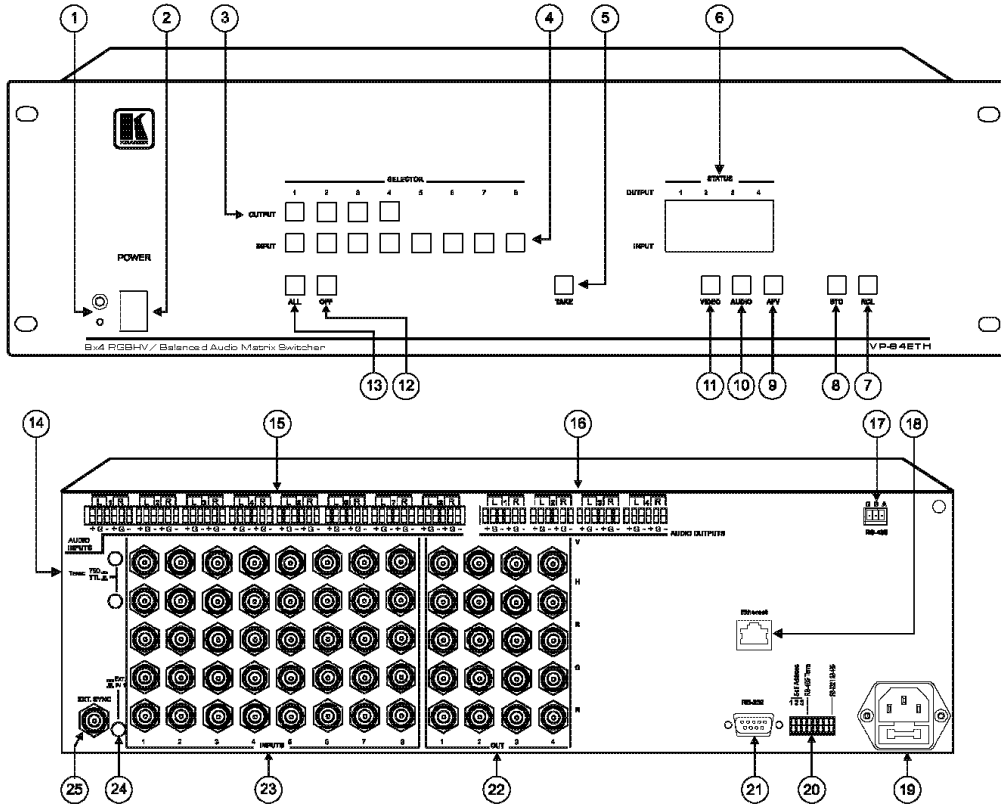

Figure 2: VP-84ETH 8x4 RGBHV / Balanced Audio Matrix Switcher





## Your RGBHV / Balanced Audio Matrix Switcher

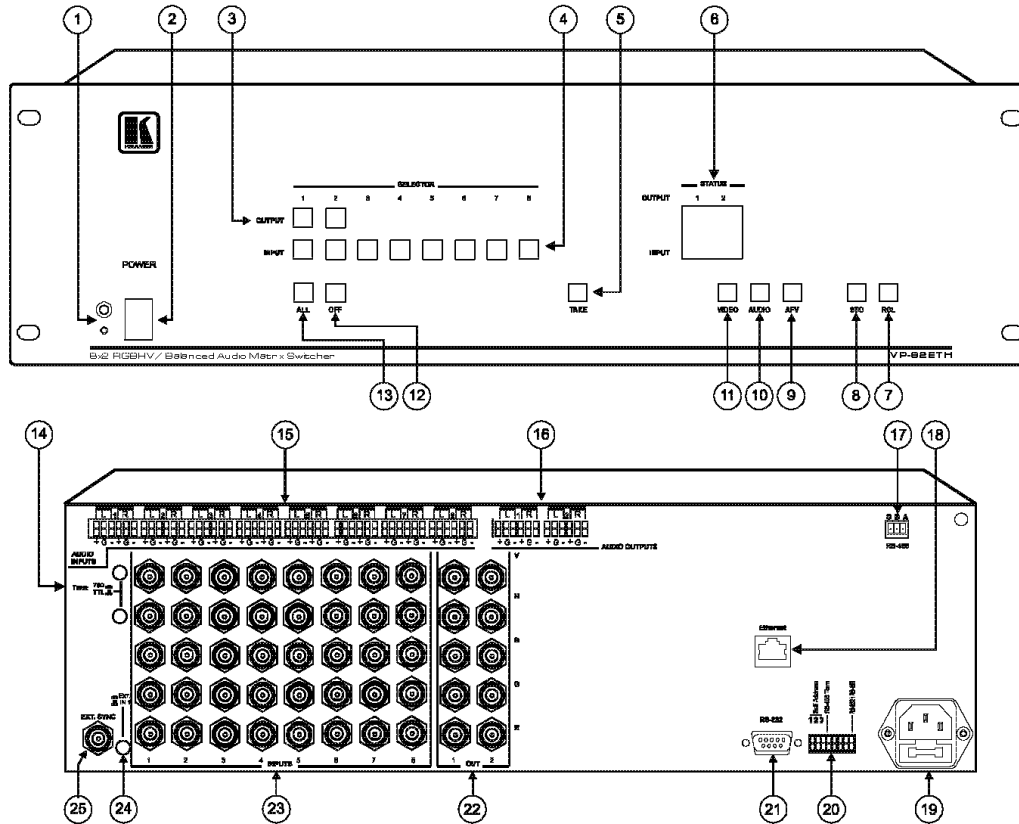

Figure 3: VP-82ETH 8x2 RGBHV / Balanced Audio Matrix Switcher

Your RGBHV / Balanced Audio Matrix Switcher

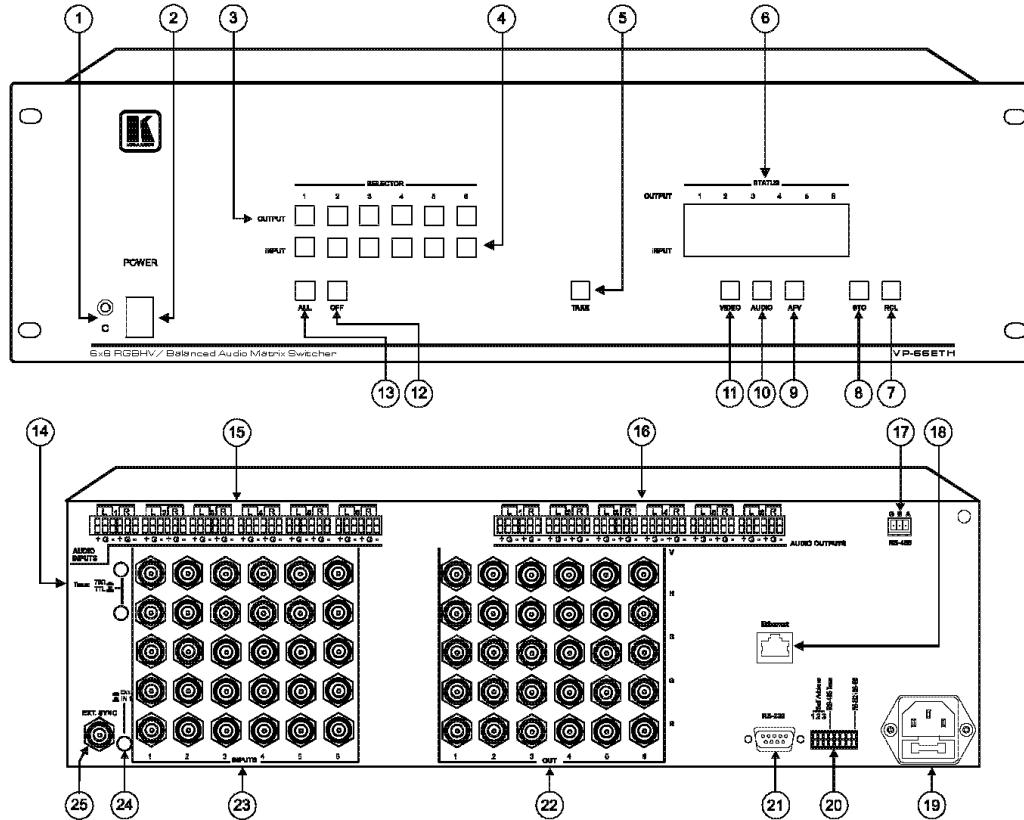

Figure 4: VP-66ETH 6x6 RGBHV / Balanced Audio Matrix Switcher



Your RGBHV / Balanced Audio Matrix Switcher

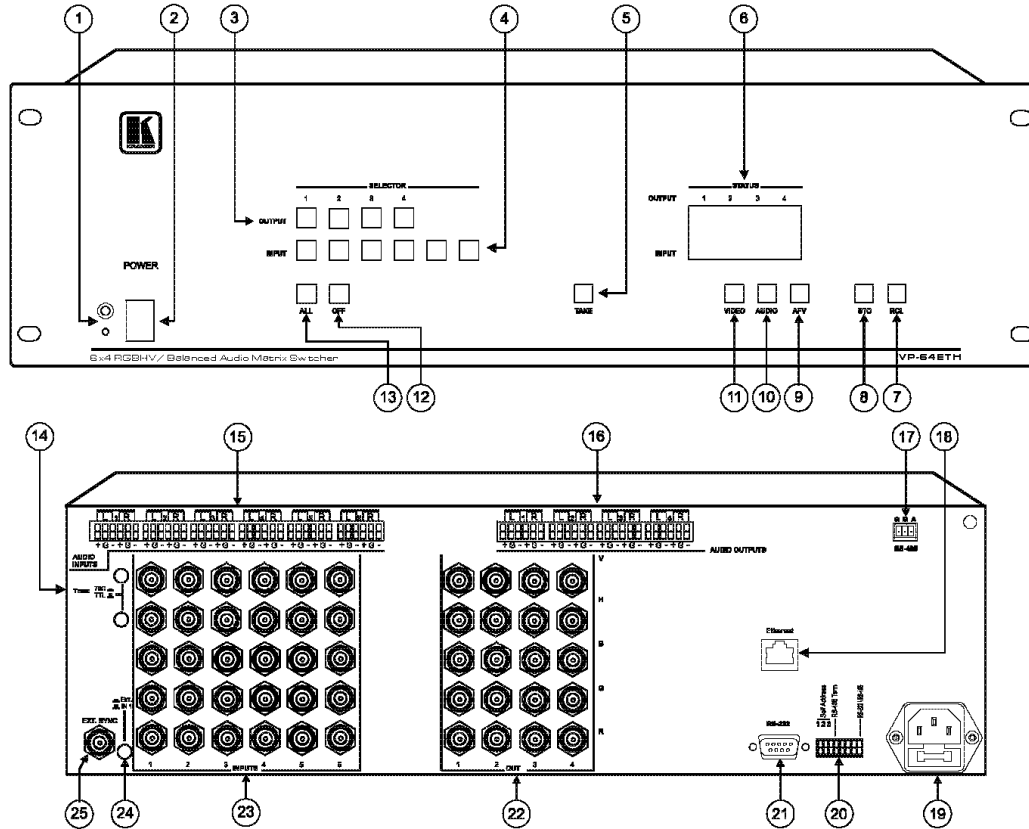

Figure 5: VP-64ETH 6x4 RGBHV / Balanced Audio Matrix Switcher

## Your RGBH / Balanced Audio Matrix Switcher

*Table 1: The RGBH / Balanced Audio Matrix Switcher Front Panel Features*

#	Feature	Function
1	IR Receiver	The red LED is illuminated when receiving signals from the Kramer Infra-Red remote control transmitter
2	<i>POWER</i> switch	Illuminated switch for turning the unit ON or OFF
3	<i>OUTPUT SELECTOR</i> Buttons	Select the output to which the input is switched
4	<i>INPUT SELECTOR</i> Buttons	Select the input to switch to the output
5	<i>TAKE</i>	Press to toggle between the Confirm mode <sup>1</sup> and the At Once mode (user confirmation per action is unnecessary)
6	<i>INPUT STATUS</i> display	Displays the selected input switched to the output (marked above each input)
7	<i>RCL</i> Button	Press the RCL button followed by an INPUT button <sup>2</sup> to recall a setup from the non-volatile memory
8	<i>STO</i> Button	Press the STO button followed by an INPUT button <sup>2</sup> to store the current settings
9	<i>AFV</i> Button	When pressed <sup>3</sup> , actions relate to the video and audio channels. The audio channels follow the video channels
10	<i>AUDIO</i> Button	When pressed <sup>3</sup> , actions relate to audio
11	<i>VIDEO</i> Button	When pressed <sup>3</sup> , actions relate to video
12	<i>OFF</i> Button	An OFF-OUTPUT combination disconnects that output from the inputs; an OFF-ALL combination disconnects all the outputs
13	<i>ALL</i> Button	Press ALL followed by an INPUT button to connect that input to all the outputs

1 When in the Confirm mode, the TAKE button blinks

2 In this case the INPUT button corresponds to the setup address number

3 The button illuminates



## Your RGBH / Balanced Audio Matrix Switcher

*Table 2: The RGBH / Balanced Audio Matrix Switcher Rear Panel Features*

#	Feature	Function
14	<i>TERM: 75Ω/TTL</i> Buttons	When both buttons are released, the upper input channels are used for TTL level H & V sync signals (RGBHV operation); When both buttons are pushed in, the input channels become analog video channels, just as the lower RGB channels, and the machine can be used for 5 identical video channels
15	<i>AUDIO INPUTS</i> <sup>1</sup> Terminal Block Connectors	Connect to the balanced stereo audio sources
16	<i>AUDIO OUTPUTS</i> <sup>1</sup> Terminal Block Connectors	Connect to the balanced stereo audio acceptors
17	<i>RS-485</i> Port	Pin G is for the Ground connection <sup>2</sup> ; pins B (-) and A (+) are for RS-485
18	Ethernet Connector	Connects to the PC or other Serial Controller through computer networking
19	Power Connector with Fuse	AC connector, enabling power supply to the unit
20	Dipswitches	Dipswitches for setup of the unit (1, 2 and 3 are for setting the machine number; 4 is for RS-485 bus termination; 5 is for Reply; 8 is for RS-485 PC communication)
21	<i>RS-232 DB 9F</i> Port	Connects to the PC or the remote controller
22	<i>OUT BNC</i> Connectors	Connect to the video acceptors
23	<i>INPUTS BNC</i> Connectors	Connect to the video sources
24	<i>EXT /IN 1</i> Button	When pushed in selects an external sync from the external source; when released selects the internal sync (inputted via the video input #1 connectors)
25	<i>EXT. SYNC</i> BNC Connector	Connects to the external sync source

---

1 VP-88ETH has 8 inputs and 8 outputs; VP-84ETH has 8 inputs and 4 outputs; VP-82ETH has 8 inputs and 2 outputs; VP-66ETH has 6 inputs and 6 outputs; VP-64ETH has 6 inputs and 4 outputs

2 The ground connection is sometimes connected to the shield of the RS-485 cable. In most applications, the ground is not connected

## 5 Connecting the RGBH / Balanced Audio Matrix Switcher

To connect the RGBH / Balanced Audio Matrix Switcher, for example the **VP-88ETH**, do the following<sup>1</sup>(see Figure 6):

1. Connect up to 8 video / RGBHV sources<sup>2</sup> to the BNC INPUT connectors<sup>3</sup>.
2. Connect up to 8 balanced stereo audio sources to the AUDIO INPUT terminal block connectors.
3. Connect up to 8 video / RGBHV acceptors to the BNC OUT connectors<sup>3</sup>.
4. Connect the corresponding balanced stereo audio acceptors<sup>4</sup> to the AUDIO OUTPUTS terminal block connectors.
5. Set the dipswitches (see section 5.5).
6. Connect a PC and/or controller (if required) to:
  - The RS-232 port and/or
  - The RS-485 port and/or
  - The ETHERNET connector
7. Connect the power cord<sup>4</sup>.

Note that:

- You can use the **VP-88ETH** for various video applications (other than RGBHV) such as Composite video, Y/C, YUV (Component video) and even SD – SDI signals (Serial Digital Video)
- You can use the **VP-88ETH** for parallel applications. For example, you can use it simultaneously as a composite video, 8x8 matrix and a Component (YUV) Matrix
- When using the **VP-88ETH** in mixed applications (such as Y/C and YUV simultaneously), select the parallel output channels for the same format, for example, if the Red and Green Channels are used for Y/C (the Red for “Y” and the Green for “C”) then the output channels should be used similarly (Red for “Y” and Green for “C”)<sup>5</sup>

---

1 Switch off the power on each device before connecting it to your VP-88ETH. After connecting your VP-88ETH, switch on its power and then switch on the power on each device

2 All signal connections using more than one cable to interconnect between the devices, should be of equal length

3 5 BNC connectors (RGBHV) per source/acceptor

4 Not illustrated in Figure 6

5 In a mixed signal application all the input channels are selected simultaneously. For example, if used for Y/C and YUV parallel switching, then when input number 1 is selected, it selects both input number 1 of the Y/C and input number 1 of the YUV channel

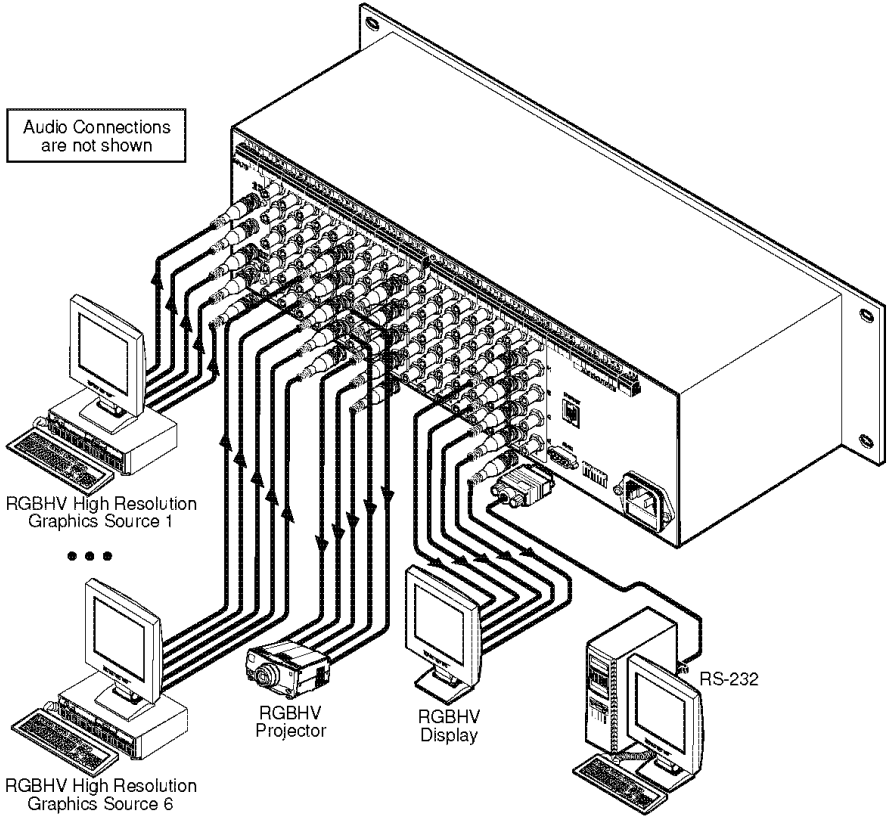

Figure 6: Connecting the VP-88ETH 8x8 RGBHV / Balanced Audio Matrix Switcher

## 5.1 Connecting the Balanced/Unbalanced Stereo Audio Input/Output

This section illustrates how to wire:

- A balanced input/output connection (see Figure 7)
- An unbalanced audio input (see Figure 8)
- An unbalanced source to the balanced input on the **VP-88ETH** (see Figure 9)

Figure 7 illustrates how to wire a balanced input/output connection:

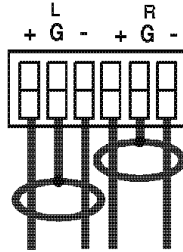

Figure 7: Connecting the Balanced Stereo Audio Input/Output

Figure 8 illustrates how to wire an unbalanced acceptor to the balanced output of the unit:

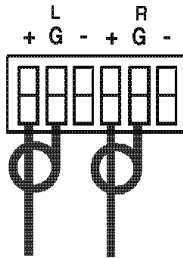

Figure 8: Connecting the Unbalanced Stereo Audio Output

Figure 9 illustrates how to connect an unbalanced source to the balanced input on the **VP-88ETH**:

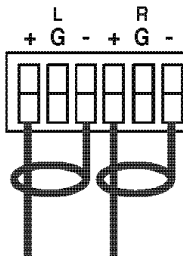

Figure 9: Connecting an Unbalanced Source to the Balanced Input



## 5.2 Controlling via RS-232 (for example, using a PC)

To connect a PC to the **VP-88ETH** unit<sup>1</sup>, using the Null-modem adapter provided with the machine (recommended):

- Connect the RS-232 DB9 rear panel port on the **VP-88ETH** unit to the Null-modem adapter and connect the Null-modem adapter with a 9-wire flat cable<sup>2</sup> to the RS-232 DB9 port on your PC

To connect a PC to the **VP-88ETH** unit<sup>1</sup>, without using a Null-modem adapter:

- Connect the RS-232 DB9 port on your PC to the RS-232 DB9 rear panel port on the **VP-88ETH** unit, as Figure 10 illustrates<sup>2</sup> (depending on whether the PC has a 9-pin or 25-pin connector)

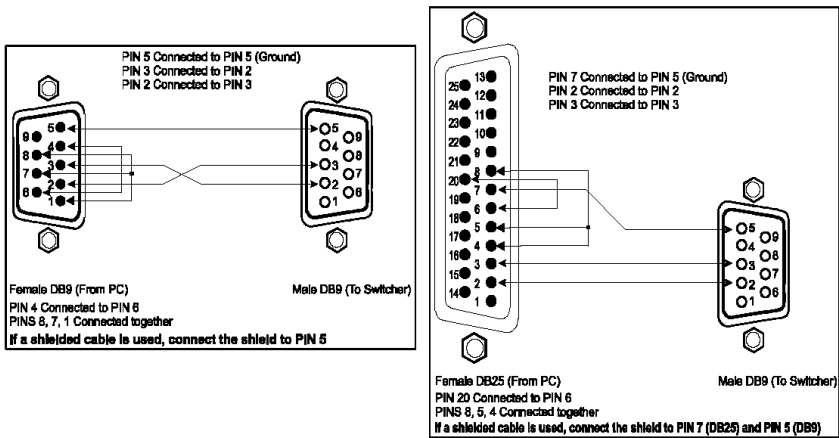

Figure 10: Connecting a PC without using a Null-modem Adapter

1 When connecting a single VP-88ETH unit via RS-232, set the SELF ADDRESS # dipswitches to SELF ADDRESS # 1, according to Table 8

2 Up to 50 feet of cabling may be used for the RS-232 connection

### 5.3 Controlling via RS-485

You can control a **VP-88ETH** unit via an RS-485 controller<sup>1</sup>, for example, a PC (equipped with an RS-485 interface) or a Master Programmable Remote Control system, such as the Kramer **RC-3000**<sup>2</sup>.

To connect an **RC-3000** to a single **VP-88ETH** unit (see Figure 11):

1. Connect the RS-485 terminal block port on the **RC-3000** to the RS-485 port on the **VP-88ETH** unit, as follows:
  - Connect the “A” (+) PIN on the RS-485 rear panel port of the **RC-3000** to the “A” (+) PIN on the RS-485 rear panel port of the **VP-88ETH** unit
  - Connect the “B” (-) PIN on the RS-485 rear panel port of the **RC-3000** to the “B” (-) PIN on the RS-485 rear panel port of the **VP-88ETH** unit
  - If shielded twisted pair cable is used, the shield may be connected to the “G” (Ground) PIN on one of the units (for example, on the **RC-3000**)
2. Set the SELF ADDRESS # dipswitches on the **VP-88ETH** unit to a SELF ADDRESS # between 2 and 8, according to section 5.5.1. Do not set as SELF ADDRESS # 1 (the Master). Terminate the RS-485 line on both the **VP-88ETH** unit (set DIP 4 to ON) and on the **RC-3000**<sup>3</sup>.

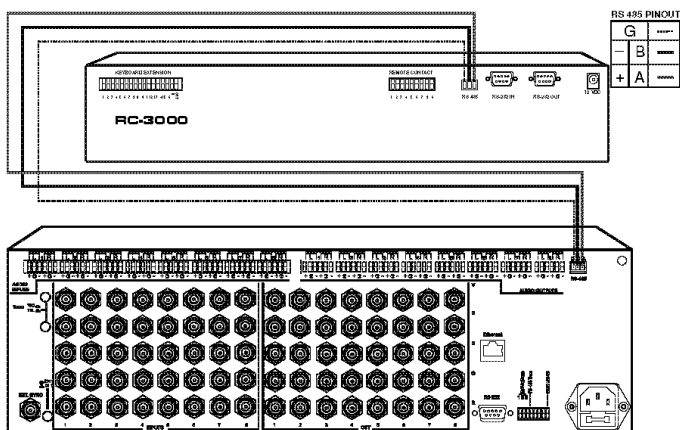

Figure 11: Controlling via RS-485 (for example, using an RC-3000)

<sup>1</sup> RS-485 can be used for control even for distances exceeding 1 km

<sup>2</sup> Previously known as the VS-3000

<sup>3</sup> Refer to the RC-3000 user manual for details of how to terminate the RS-485 line

## 5.4 Setting the ETHERNET Port and Utilities

To control your **VP-88ETH** via the ETHERNET, do the following:

1. Connect the Ethernet port of the **VP-88ETH** to the LAN port of your PC (see section 5.4.1).
2. Install and configure your ETHERNET Port (see sections 5.4.2 through 5.4.4).
3. Install the COM Port Redirector to control the **VP-88ETH** (see section 5.4.5).

### 5.4.1 Connecting the VP-88ETH Ethernet Port

You can connect the ETHERNET port either via a crossover cable (see section 5.4.1.1) or a straight through cable (see section 5.4.1.2).

#### 5.4.1.1 Connecting via a Crossover Cable

Connect the ETHERNET port of the **VP-88ETH** to the LAN port on your PC, via a crossover cable with RJ-45 connectors, as Table 3 defines.

*Table 3: Crossover Cable RJ-45 PINOUT*

Side 1		Side 2	
PIN	Wire Color	PIN	Wire Color
1	White-orange	1	White-green
2	Orange	2	Green
3	White-green	3	White-orange
4	Blue	4	Blue
5	White-blue	5	White-blue
6	Green	6	Orange
7	White-brown	7	White-brown
8	Brown	8	Brown

This type of connection is recommended for identification of the factory default IP Address of the **VP-88ETH** during the initial configuration.

After connecting the ETHERNET port, configure your PC as follows:

1. Right-click the My Network Places icon on your desktop.
2. Select **Properties**.
3. Right-click Local Area Connection Properties.
4. Select **Properties**.

The Local Area Connection Properties window appears.

5. Select the Internet Protocol (TCP/IP) and click the **Properties** Button (see Figure 12).

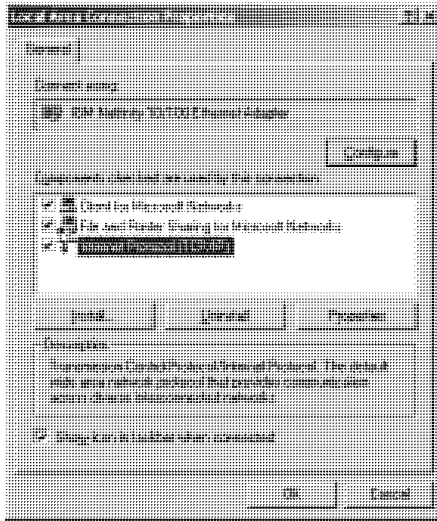

Figure 12: Local Area Connection Properties Window

6. Select Use the following IP Address, and fill in the details as shown in Figure 13.
7. Click **OK**.

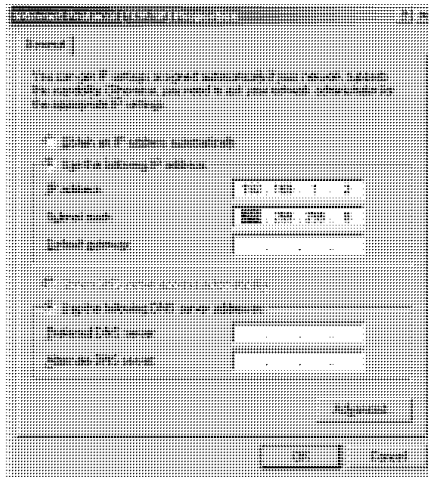

Figure 13: Internet Protocol (TCP/IP) Properties Window

### 5.4.1.2 Connecting via a Straight-Through Cable

If connecting the ETHERNET port of the **VP-88ETH** to the LAN port on a network hub or network router, use a straight-through cable with RJ-45 connectors, as Table 4 defines:

*Table 4: Straight-through Cable RJ-45 PINOUT*

Side 1		Side 2	
PIN	Wire Color	PIN	Wire Color
1	White-orange	1	White-orange
2	Orange	2	Orange
3	White-green	3	White-green
4	Blue	4	Blue
5	White-blue	5	White-blue
6	Green	6	Green
7	White-brown	7	White-brown
8	Brown	8	Brown

### 5.4.2 Installing and Running the XPort Configuration Software

To configure the ETHERNET Port, you have to install and run the XPort configuration software.

It is important to consider the following points before logging into and configuring the ETHERNET Port:

- The **VP-88ETH** IP address must be configured before a network connection is available
- Only one person at a time may be logged into the network port. This eliminates the possibility of several people simultaneously attempting to configure the Device Server
- Network port logins can be disabled. The system manager will not be able to access the unit. This port can also be password protected

#### 5.4.2.1 Install XPort™ Installer

To install the XPort™ Installer, do the following:

1. Insert the product CD into your CD-ROM drive.
2. Run the XPort installer setup.
3. Respond to the installation wizard prompts.
4. Restart your system.

### 5.4.2.2 Run XPort™ Installer

Click the **Start** button on the Task Bar and select **Programs\XPort Installer\XPort Installer**. The XPort™ Installer main dialog box displays (Figure 14).

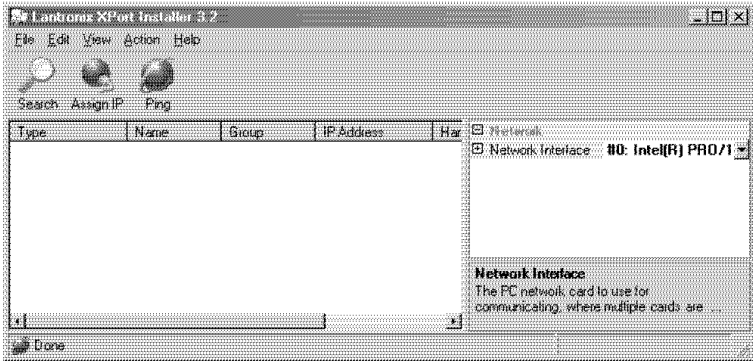

Figure 14: XPort™ Installer Main Dialog Box

To search for devices, click the **Search** icon or select **Search Network** from the Action menu.

### 5.4.2.3 Assign IP Address

Figure 15 shows a device found on the network, with the IP addresses assigned at the factory. The Hardware Address is an individual permanent address assigned to a particular device on the network. The Hardware Address can be found on the product label inside the unit.

**Note:** Click on a device to view its attributes

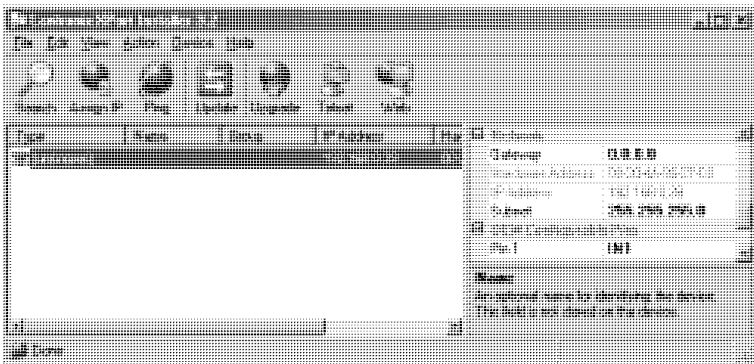
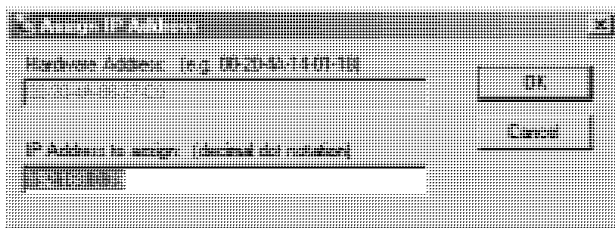

Figure 15: Device Found on the Network

To change the IP address, first select the device from the list, then click the **Assign IP** icon or select **Assign IP Address** from the Action menu. The hardware address and IP address are loaded into the Assign IP Address dialog box (Figure 16).



*Figure 16: IP Address Assignment Dialog Box*

Enter the new IP Address and click **OK**. The new IP Address will appear in the main window.

#### 5.4.2.4 Test the IP Address

To test the IP Address, do the following:

1. Select the device from the main window list.
2. Click the **Ping** icon or select **Ping** from the Action menu. The Ping Device dialog box shows the IP Address of the selected device.
3. Click the **Ping** button and the results will be displayed in the Status window. Use the **Clear Status** button to clear the window so you can ping the device again.
4. Click the **Close** button to close the dialog box and return to the main window.

**Note:** If you do not receive "Reply" messages, make sure the unit is properly attached to the network and that the IP address assigned is valid for the particular network segment you are working with. If you are not sure, check with your Systems Administrator.

### 5.4.3 Configuring the ETHERNET Port

You must configure the ETHERNET Port so that it can communicate on a network with your serial device. For example, you must set the way the unit will respond to serial and network traffic, how it will handle serial packets, and when to start or close a connection. You can configure your unit locally or remotely using the following procedures:

- Use the XPort™ Installer to configure the unit. Some features are only available through the XPort™ Installer menus
- Use a standard Web browser to access the unit's internal Web pages and configure the unit over the network (see section 5.4.4)  
**This is the easiest and preferred method**
- Make sure that the Java™ 2 Runtime Environment (Standard Edition, Version 1.4.1 or higher) software is installed on your PC. If not, download it from: <http://java.sun.com>

The unit's configuration is stored in non-volatile memory and is retained without power. The unit performs a reset after the configuration has been changed and stored.

### 5.4.4 Using the Web Manager Page

To configure the ETHERNET Port via a Web browser, first click one of the devices listed in the window, and then click the **Web** icon. The Web-Manager window now displays in your browser.

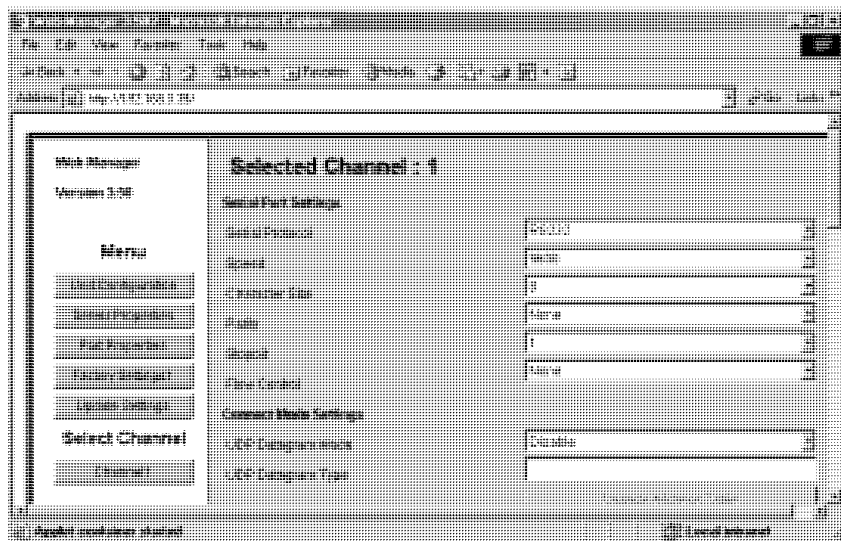

Figure 17: ETHERNET Port Web-Manager



Table 5 describes the Web Manager window buttons.

Table 5: Web Manager Window Buttons

Button	Function
Unit Configuration	Press to enter the Server Configuration and the Port Configuration settings (section 5.4.4.1)
Server Properties	Press to enter the Server Properties and change the server properties by editing any of the fields (section 5.4.4.2)
Port Properties	Press to enter the Port Properties and modify them
Factory Settings 1	Press to set to factory default settings
Update Settings	Press to update settings
Channel 1	Disabled

When in the Web Manager window:

1. Use the menu buttons to navigate to sub pages where you can configure server settings. See explanations of the configuration parameters in the following sections.
2. When you are finished, click the **Update Settings** button to save your settings.

#### 5.4.4.1 Unit Configuration Button

Click the **Unit Configuration** button to display the following dialog box (Figure 18). This page contains the Server Configuration and the Port Configuration settings. These are static settings read from the device.

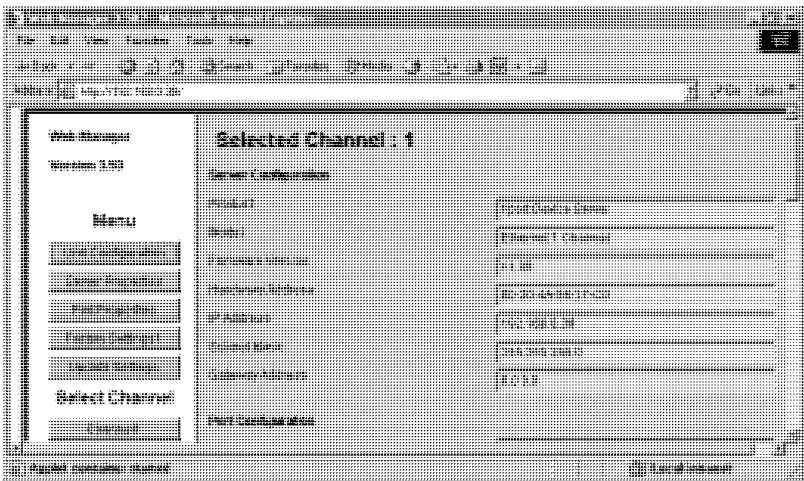

Figure 18: Server Configuration in the Unit Configuration Window

Figure 18 and Figure 19 show the information available in the Unit Configuration window.

Port Configuration	
Local Port Number	10001
Remote Port Number	
Serial Port Speed	9600
Flow Control	00
Interface Mode	FC
Connect Mode	CO
Disconnect Mode	00
First Mode	00
Port Control	00
UDF Extension Type	Not Supported By These Settings

Figure 19: Port Configuration in the Unit Configuration Window

#### 5.4.4.2 Server Properties Button

Click the **Server Properties** button to display the following dialog box (see Figure 20).

You can change the server properties by editing any of the fields. Hold the cursor over one of the fields to display Help messages.

Server Properties	
IP Address	192.168.0.30
Subnet Mask	255.255.255.0
Outgoing Address	0.0.0.0
High Performance	Enable
Telnet Password	0000

Figure 20: Server Properties in the Unit Configuration Window

- Changing the IP address will require you to enter the new IP address in the browser to reload the page
- In the Telnet Password field, enter a password to prevent unauthorized access to the Setup Mode via a Telnet connection to port 9999. The password is limited to 4 characters. (An enhanced password setting of 16 characters is available under Security Settings on the Telnet Setup Mode window)

### 5.4.4.3 Port Properties Button

Click the **Port Properties** button to display the following dialog boxes. Make sure that the Serial Port Settings window is set according to Figure 21<sup>1</sup>.

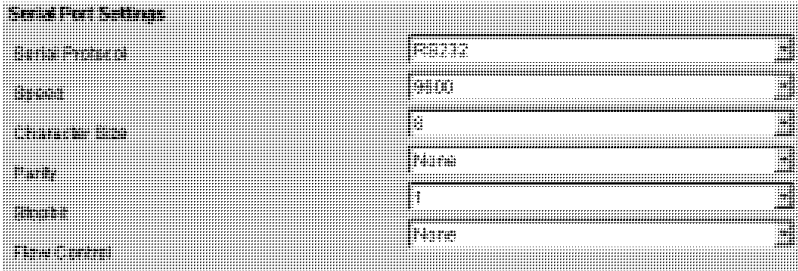

Figure 21: Serial Port Settings Window

Make sure that the Local Port in the Dedicated Connection window is set according to Figure 22.

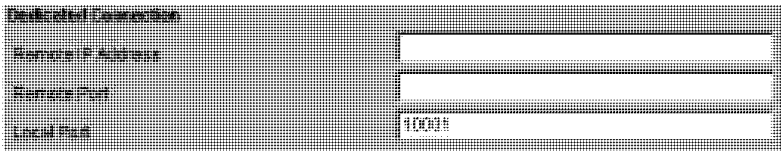

Figure 22: Dedicated Connection Window

Make sure that the Flush Mode Input buffer window is set according to Figure 23.

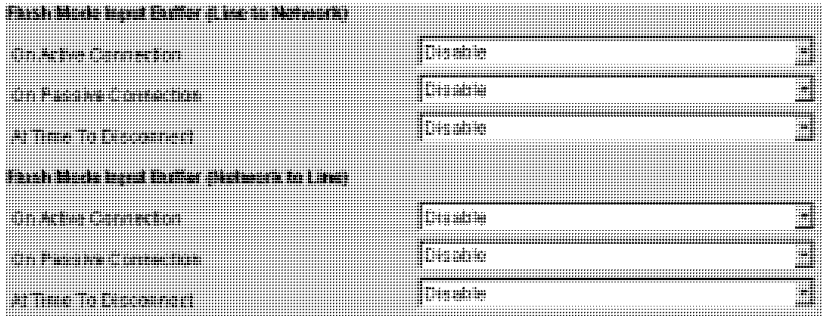

Figure 23: Flush Mode Input Buffer Window

<sup>1</sup> You can change the server properties by selecting the desired properties from the drop down list

## 5.4.5 Controlling a Machine using the Com Port Redirector

The Com Port Redirector allows any PC running Windows to use ports on a network server as if they were connected directly to the PC. The Redirector creates a virtual COM port within Windows, which for most purposes acts just like the selected serial port on the server.

### 5.4.5.1 Installing the Com Port Redirector

To install the Com Port Redirector, do the following:

1. Perform the appropriate step to start the installation:
  - If the Com Port Redirector is on a CD-ROM, insert the CD-ROM into the computer's CD-ROM drive
  - If you downloaded the Com Port Redirector, double-click the downloaded file
  - Either step displays the Redirector - Welcome screen in Figure 24



Figure 24: Com Port Redirector Welcome Screen

2. Click the **Continue** button and follow the on-screen installation instructions.
3. After installation, the Setup Complete dialog box appears (Figure 25).

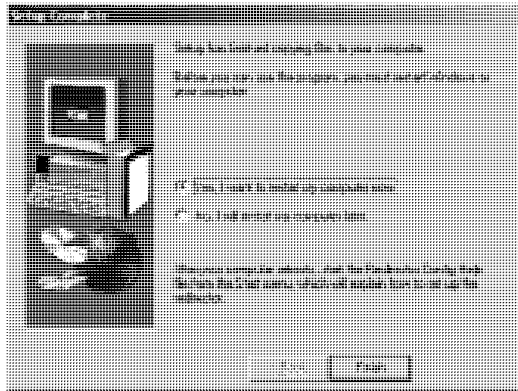

Figure 25: Setup Complete Dialog Box

4. Click **Finish** to complete the installation and restart your computer.
5. Click the **Start** button in the Windows Taskbar, point to **Programs**, point to **Lantronix Redirector**, and click **Configuration**. The Com Port Redirector Configuration window appears (see Figure 26).

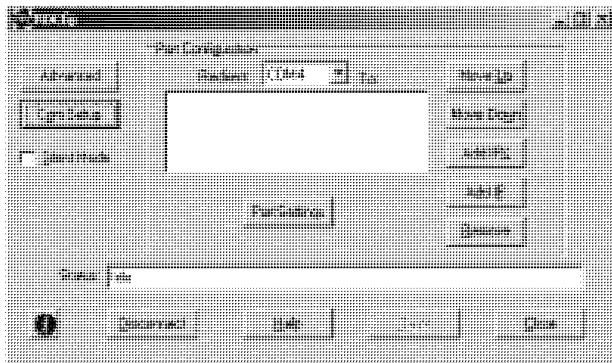

Figure 26: Com Port Redirector Configuration Window

6. Click the **Com Setup** button. A Port Setup dialog box appears (Figure 27), with the first logical communications port checked.
  - The physical communication ports on the computer where the Com Port Redirector is installed are grayed-out and unavailable. In Figure 27, these are Com1 through Com3. Your unavailable communication ports may vary

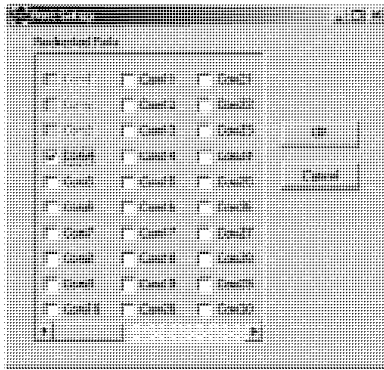

Figure 27: Port Setup Window

7. Click all the logical ports to which the PC will be redirected. A checkmark appears next to each logical port selected. Each port selected will be available from the **Redirect To** drop-down list in the Com Port Redirector Configuration window (see Figure 26).
8. To deselect a port, click it again to remove the checkmark next to it. Removing the checkmark indicates that the port will not be available from the **Redirect To** drop-down list.
9. When finished, click **OK**.

**Note:** After you use the Port Setup dialog box to add or remove Com ports, restart your computer.

#### 5.4.5.2 Configuring the Com Port Redirector

Com Port Redirector is a software utility for network-enabling legacy software applications that do not have network support. Com Port Redirector installs virtual Windows® communication ports. These virtual communication ports are redirected over a network to the serial port of the **VP-88ETH**.

##### Configuration Guidelines

Observe the following general guidelines when preparing the **VP-88ETH** for use with the Com Port Redirector:

- The machine to which the Com Port Redirector will connect must have an IP address
- The PC running the Com Port Redirector must have a good network connection to the **VP-88ETH**

- If redirecting over a Wide Area Network (WAN), both the PC and the **VP-88ETH** must have a correct gateway address configured in their TCP/IP<sup>1</sup> settings

### Redirector Configuration

Before using the Com Port Redirector, you have to configure the **VP-88ETH** Ethernet Port. To do so, do the following:

- Assign a compatible IP address to the device server
- Set the serial settings (baud rate, parity, flow control, data bits)
- Set the port number to **10001** (recommended)

For specific instructions, see section 5.4.1.

To configure the Com Port Director:

1. Click the **Start** button in the Windows Taskbar, point to **Programs**, point to **Lantronix Redirector**, and click **Configuration**. The Com Port Redirector Configuration window appears (see Figure 26).
2. Using the **Redirect To** drop-down list at the top of the Com Port Redirector Configuration window, click a redirected Com port.
3. Click the **Add IP** button. The IP Service Setup dialog box appears (see Figure 28).

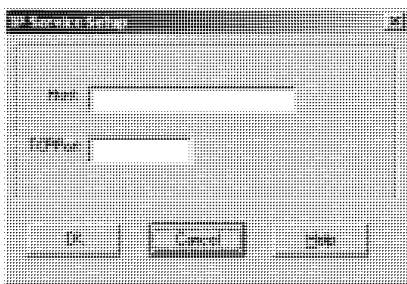

Figure 28: IP Service Setup Dialog Box

4. In the **Host** field, enter the IP address of the **VP-88ETH**.
5. In the **TCPPort** field, type **10001** for Channel 1 (according to the local port, configured in the **VP-88ETH** unit).
6. Click **OK**.

---

<sup>1</sup> TCP/IP is Transmission Control Protocol/Internet Protocol

7. Click the **Port Settings** button. The Port Settings dialog box appears. Figure 29 shows the Port Settings dialog box and Table 6 describes its settings.
8. Check **Raw Mode**.

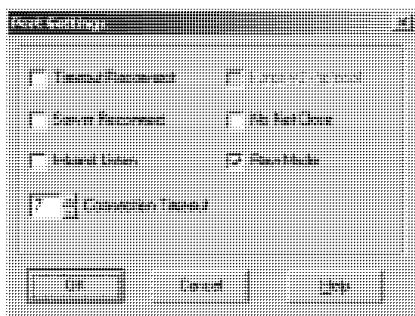

Figure 29: Port Settings Window

9. Click **OK**.
10. Click the **Save** button (see Figure 26).
11. Click the **Close** button (see Figure 26).

Table 6: Port Settings Description

Setting	Description
Timeout Reconnect	If checked, the Com Port Redirector re-establishes the connection if the connection times out <sup>1</sup>
Server Reconnect	If checked, the Com Port Redirector re-establishes the connection if the server closes it <sup>1</sup>
Inband Listen	If checked, the Com Port Redirector uses the inband redirector protocol on inbound connections from a <b>VP-8BETH</b> . This protocol allows settings like modem signals, baud rate and parity to be exchanged between Com Port Redirector and the server.
Connection Timeout	Specifies the maximum number of seconds that the Com Port Redirector waits for a connection to be made before giving up on this attempt. If Timeout Reconnect is enabled, each connection attempt lasts this long. If Timeout Reconnect is disabled, the connection attempt fails after this interval and no more attempts are made.
Force v2 Protocol	N/A
No Net Close	If checked, prevents the network connection from being dropped when the communications application is closed. To drop the connection, click the Disconnect button in the Com Port Redirector Configuration window. This allows applications to close and reopen ports, without waiting for the network connection to be reestablished and negotiated.

<sup>1</sup> When auto-reconnecting, the Com Port Redirector tries to reconnect until the connection succeeds or you click the Cancel button in the pop-up connection dialog box. If the port was closed by the communications application or by clicking Disconnect, the Com Port Redirector does not try to auto-reconnect



Setting	Description
Raw Mode	If checked, Raw Mode forms a raw TCP connection to the server's serial port, accelerating the connection between the communications application and the server, without sending configuration or status information from the PC to the server. When using Raw Mode, configure the Com Port Redirector and your <b>VP-88ETH</b> to use the same port number

### Verify Connectivity

After configuring the Com Port Redirector and the **VP-88ETH**, use a terminal emulation program such as HyperTerminal to verify connectivity from the Com Port Redirector to the **VP-88ETH**. To verify connectivity between the Com Port Redirector and the **VP-88ETH** using HyperTerminal:

1. Click the **Start** button in the Windows Taskbar, point to **Programs**, point to Accessories, point to Communications, and click HyperTerminal.
2. Open a new session to the virtual Com port configured to connect to the device server.
3. When the HyperTerminal window opens, a pop-up window displays: *Attempting to connect to service*.  
If this message is replaced by: *Successfully redirected to service*, the connection from the Com Port Redirector to the device server was successful.  
However, if the message is replaced by *Failed to connect to any service*, the connection failed. Ensure your settings are correct.
4. To hide the pop-up window, check **Silent Mode** on the Com Port Redirector Configuration window (Figure 30).

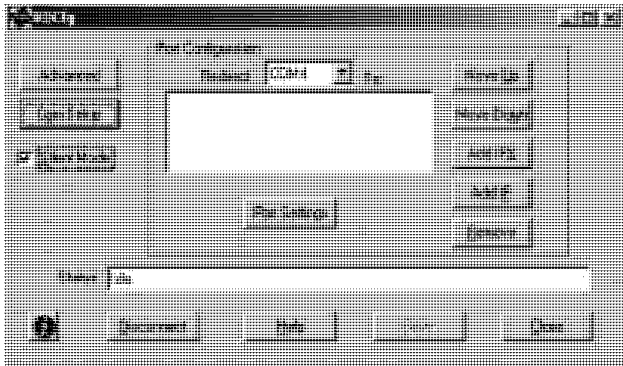

Figure 30: Silent Mode Checked in the RDCfg Window

### 5.4.6 Using the Com Port Redirector

Observe the following general guidelines when using the Com Port Redirector:

- Do not run the Com Port Redirector with other software that installs a virtual com port
- Do not run the Com Port Redirector with other Com Port Redirection software on the same PC

### 5.5 Setting the VP-88ETH Dipswitches

This section describes the machine set-up and dipswitch selection.

Figure 31 illustrates the factory default dipswitches and Table 7 describes them.

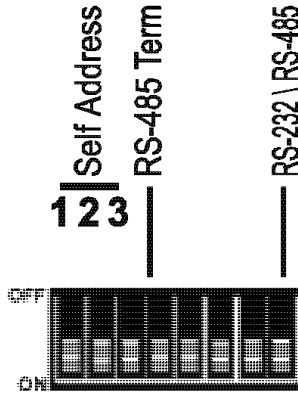

Figure 31: VP-88ETH Dipswitches

Table 7: Dipswitch Settings

DIPS	Function	Description
1, 2, 3	Self Address	Determines the position of the machine in the input expansion configuration
4	RS-485 TERM	ON for RS-485 Line Termination OFF for no RS-485 Line Termination
5	Reply	ON enables reply from switcher to PC OFF disables reply from switcher to PC
6, 7	RESERVED	
8	RS-232 \ RS-485	ON enables RS-232 communication between switcher and PC OFF disables reply from switcher to PC

### 5.5.1 Setting the SELF ADDRESS Dipswitches

The SELF ADDRESS determines the position of a **VP-88ETH** unit in the sequence, specifying which **VP-88ETH** unit is being controlled when several **VP-88ETH** units are controlled by a PC or serial controller. Set the SELF ADDRESS on a **VP-88ETH** unit via DIPS 1, 2, and 3, according to Table 8.

- When using a stand-alone **VP-88ETH** unit, set the SELF ADDRESS to 1
- When connecting more than one **VP-88ETH** unit, set the first machine (the Master) connected via RS-232, as SELF ADDRESS # 1. The Master connects to the PC via the RS-232 port. The other **VP-88ETH** slave units (each set to a SELF ADDRESS # between 2 and 8) interconnect via their RS-485 ports to the RS-485 port on the Master

*Table 8: MACHINE # Dipswitch Settings*

MACHINE #	DIPS		
	1	2	3
1 Master	ON	ON	ON
2	OFF	ON	ON
3	ON	OFF	ON
4	OFF	OFF	ON
5	ON	ON	OFF
6	OFF	ON	OFF
7	ON	OFF	OFF
8	OFF	OFF	OFF

### 5.6 Setting the Reply Dipswitch

Dipswitch #5 (the Reply dipswitch) enables or disables a reply from the **VP-88ETH** to the PC.

This is desirable, so that the controlling device “knows” that the controlled device has carried out its instructions. When an RS-485 connection is used for communication between the Matrix Switcher and the PC, dipswitch #8 should be set to OFF. In some applications, it may be desirable for some machines not to reply to instructions received on the RS-232 and RS-485 ports. In this case, the **Reply**, or acknowledgement commands should be disabled.

### 5.7 Setting the RS-232\RS-485 Dipswitch

The RS-232\RS-485 dipswitch allows you to enable RS-232 communication between the Matrix Switcher and the PC.

## 6 Operating Your VP-88ETH Machine

Operate your **VP-88ETH** via:

- The front panel buttons
- RS-232/RS-485 serial commands transmitted by a touch screen system, PC, or other serial controller
- ETHERNET
- The Kramer **RC-IRI** Infra-Red Remote Control Transmitter<sup>1</sup>

### 6.1 Displaying the Unit Characteristics

The **VP-88ETH** 7-segment Display<sup>2</sup> shows the selected audio<sup>3</sup> or video<sup>4</sup> input switched to the marked output.

The unit's characteristics<sup>5</sup> are displayed in the following circumstances:

- Immediately (and automatically) after switching on the power; and
- When simultaneously pressing and holding for 3 seconds the INPUT buttons: 1, 2 and 3 (see section 6.6)

### 6.2 Selecting and Connecting an Output and/or Input

To switch an input to an output, press the desired OUTPUT button, followed by the desired INPUT button.

In addition, to:

- Disconnect a video/audio Input from a specific output, press the desired OUTPUT button followed by the OFF button. To disconnect all the outputs, press the ALL button, followed by the OFF button
- Connect a video/audio input to all outputs, press the ALL button followed by the INPUT button corresponding to the input that is to be routed to all the outputs

---

1 Previously known as the IR-1/IR-1-01

2 Item 6 in Table 1

3 When the Audio button illuminates, that is, when the audio breakaway mode is selected

4 When the Video button illuminates, that is, when the video breakaway mode is selected

5 Machine model and software version

## 6.3 Choosing the Audio-Follow-Video or Breakaway Option

You can switch stereo audio signals in one of two ways, either:

- Audio-follow-video (AFV), in which all operations relate to both the video and the audio channels; or
- Breakaway, in which video and audio channels switch independently

### 6.3.1 Setting the Audio-Follow-Video Option

To set the Audio-follow-video (AFV) option press the AFV button:

- If the AUDIO and VIDEO configurations are the same, then the AFV button illuminates. The audio will follow the video
- If the AUDIO differs from the VIDEO, then the TAKE and the AUDIO buttons will flash. Also, the audio outputs in the STATUS 7-segment display, which will be changed, will flash<sup>1</sup>. Press the TAKE button to confirm the modification. The audio will follow the video

### 6.3.2 Setting the Breakaway Option

To set the Breakaway option:

Press either the AUDIO (for audio control only) or the VIDEO (for video control only) button:

- If the AUDIO button illuminates, switching operations relate to Audio
- If the VIDEO button illuminates, switching operations relate to Video

The STATUS window displays audio or video settings, according to your selection.

## 6.4 Confirming Settings

You can choose to work in the At Once or the Confirm mode. When the **VP-88ETH** operates in the At Once mode, pressing an OUTPUT-INPUT combination implements the switch immediately. In the Confirm mode, the TAKE button must be pressed to authorize the switch.

### The At Once Mode

In the At Once mode, you save time as execution is immediate and actions require no user confirmation. However, no protection is offered against changing an action in error.

---

<sup>1</sup> Warning that you are about to modify the audio configuration for AFV operation

## The Confirm Mode

In the Confirm mode:

- You can key-in several actions and then confirm them by pressing the TAKE button, to simultaneously activate the multiple switches
- Every action requires user confirmation, to protect against erroneous switching
- Execution is delayed<sup>1</sup> until the user confirms the action

### 6.4.1 Toggling between the At Once and Confirm Modes

To toggle between the At Once and Confirm modes, do the following:

1. Press the TAKE button to toggle from the At Once mode<sup>2</sup> to the Confirm mode<sup>3</sup>.  
Actions now require user confirmation and the TAKE button illuminates.
2. Press the illuminated TAKE button to toggle from the Confirm mode back to the At Once mode.  
Actions no longer require user confirmation and the TAKE button no longer illuminates.

### 6.4.2 Confirming a Switching Action

To confirm a switching action (in the Confirm mode), do the following:

1. Press an OUTPUT-INPUT combination.  
The corresponding input number that is displayed in the STATUS 7-segment Display blinks. The TAKE button also blinks.
2. Press the blinking TAKE button to confirm the action.  
The corresponding input number that is displayed in the STATUS 7-segment Display no longer blinks. The TAKE button illuminates.

To confirm several actions (in the Confirm mode), do the following:

1. Press each OUTPUT-INPUT combination in sequence.  
The corresponding input numbers that are displayed in the STATUS 7-segment Display blink. The TAKE button also blinks.
2. Press the blinking TAKE button to confirm all the actions.  
The corresponding input numbers that are displayed in the STATUS 7-segment Display no longer blink. The TAKE button illuminates.

---

1 Failure to press the TAKE button within one minute (the Timeout) will abort the action

2 The TAKE button does not illuminate

3 The TAKE button illuminates



## 6.5 Storing/Recalling Input/Output Configurations

You can store and recall up to 8 input/output<sup>1</sup> configurations (or setups) in non-volatile memory, using the INPUT SELECTOR buttons 1 to 8.

### 6.5.1 Storing an Input/Output Configuration

To store the current status in memory, do the following:

1. Press the STO button.  
The STO button blinks.
2. Press one of the INPUT SELECTOR buttons from 1 to 8. This will be the setup # in which the current status is stored.  
The memory stores the data at that reference.

### 6.5.2 Recalling an Input/Output Configuration

To recall an input/output configuration, do the following:

1. Press the RCL button.  
The RCL button blinks.
2. Press the appropriate INPUT SELECTOR button (the INPUT SELECTOR button # corresponding to the setup #). The memory recalls the stored data from that reference.

### 6.5.3 Deleting an Input/Output Configuration

To delete an input/output configuration, do the following:

1. Press the STO and RCL buttons simultaneously.  
Both the STO and RCL buttons blink.
2. Press the appropriate INPUT SELECTOR button.  
This erases that specific input/output configuration from the memory, leaving it empty and available<sup>2</sup>.

## 6.6 Resetting the Machine

To reset the machine, press INPUT buttons 1, 2 and 3 simultaneously. The machine resets itself and a 7-segment self-test is automatically performed.

---

<sup>1</sup> For VP-88ETH, VP-84ETH and VP-82ETH, up to 8 input/output configurations; for VP-66ETH and VP-64ETH, up to 6 input/output configurations

<sup>2</sup> Storing a new configuration over a previous configuration (without deleting it first) replaces the previous configuration

## 6.7 Using the TERM: 75Ω/TTL Buttons

In some graphics and multimedia applications, only 4 channels are used – RGBS. The sync channel uses Composite Sync format (not separated to Horizontal and Vertical), and is usually at analog signal levels (1 Volt approx.). Composite sync channel is rarely of the TTL type.

Use the TERM. 75Ω/TTL buttons as follows:

- Release both buttons when the matrix is to be used in an RGBHV application
- Press the H channel button to the 75Ω position, when a Composite Analog sync<sup>1</sup> is used
- Press both the H and the V TERM. buttons to the 75Ω position, when the switcher is used for analog or SDI signals<sup>2</sup>

**If this channel is not properly set up, damage may incur to the signal source, acceptor or the Matrix!**

## 7 Controlling Several RGBHV / Balanced Audio Matrix Switchers

You can connect up to eight single **VP-88ETH** units with control from a PC or serial controller via RS-232 and RS-485, or up to seven single units via RS-485.

### 7.1 Control Configuration via RS-232 and RS-485

To control up to eight **VP-88ETH** units – with control from a PC or serial controller – via RS-232 and RS-485, as Figure 32 illustrates, do the following:

1. Connect the video sources and acceptors, the appropriate audio sources and acceptors, and the power cord to each **VP-88ETH** unit.
2. On each **VP-88ETH**, set the SELF ADDRESS # as required<sup>3</sup>
3. Connect the RS-232 port on the first **VP-88ETH** unit to the PC using the Null-modem adapter provided with the machine (see section 5.2).
4. Interconnect the RS-485 ports on all the **VP-88ETH** units: from the RS-485 port on the first **VP-88ETH** unit, to the RS-485 port on the second **VP-88ETH** unit, and so on – up to the RS-485 port on the eighth **VP-88ETH** unit.

---

<sup>1</sup> This should be verified by the user from the specification of the RGBS source

<sup>2</sup> All the 5 channels are identical in specification and bandwidth, and may be used for any application

<sup>3</sup> Set the first unit to SELF ADDRESS # 1 (Master), the second unit to SELF ADDRESS # 2, and so on - up to SELF ADDRESS # 8 for the eighth unit



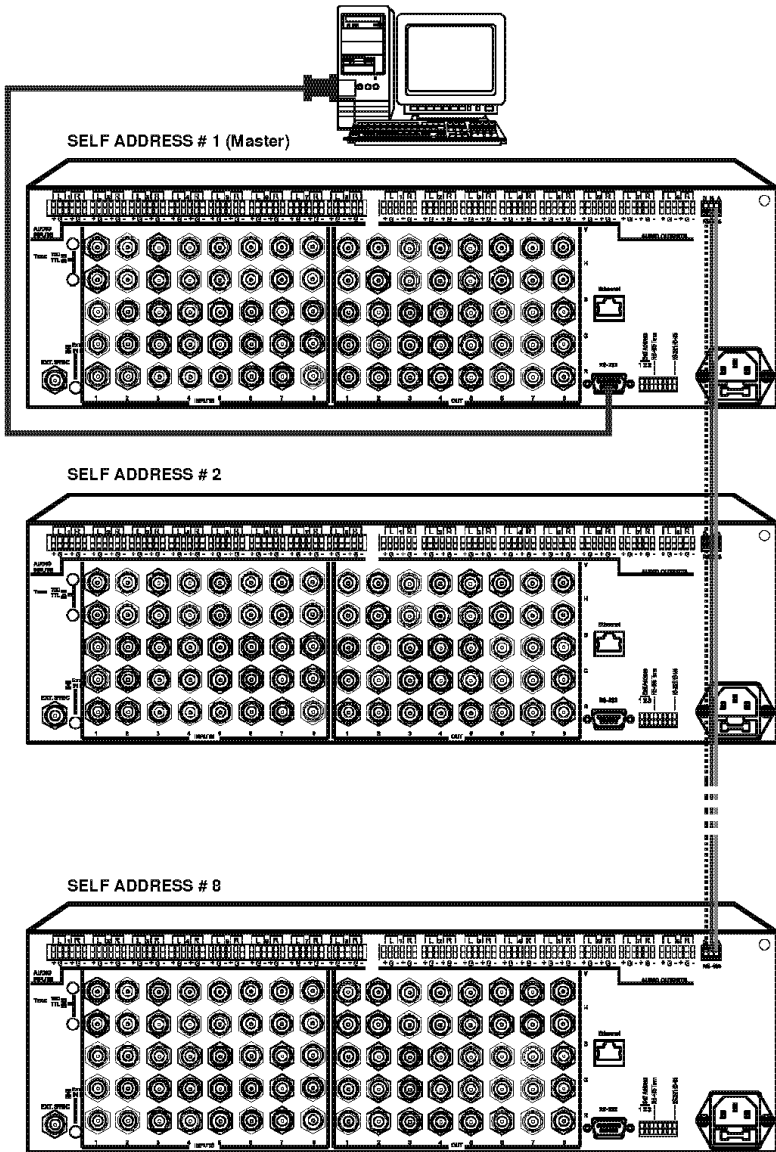

Figure 32: Control Configuration via RS-232 and RS-485

## 7.2 Control Configuration via RS-485

To control up to seven single **VP-88ETH** units via an RS-485 controller, for example, a Master Programmable Remote Control system, such as the Kramer **RC-3000**<sup>1</sup>, or a PC (equipped with an RS-485 interface), as Figure 33 illustrates, do the following<sup>2</sup>:

1. Connect the video sources and acceptors, the appropriate audio sources and acceptors, and the power cord to each **VP-88ETH** unit.
2. On each **VP-88ETH** unit, set the SELF ADDRESS # dipswitches, as required. For example, set the first **VP-88ETH** unit to SELF ADDRESS # 2, the second **VP-88ETH** unit to SELF ADDRESS # 3, and so on - up to SELF ADDRESS # 8 for the seventh **VP-88ETH** unit (see section 5.5.1).
3. Terminate the RS-485 line on both the **RC-3000**<sup>3</sup> and on the last **VP-88ETH** unit (set DIP 4 to ON).
4. Connect the RS-485 ports on the **RC-3000** to the RS-485 ports on each of the **VP-88ETH** units, as follows:
  - Connect the “A” (+) PIN on the RS-485 rear panel port of the **RC-3000** to the “A” (+) PIN on the RS-485 rear panel ports of the **VP-88ETH** units
  - Connect the “B” (-) PIN on the RS-485 rear panel port of the **RC-3000** to the “B” (-) PIN on the RS-485 rear panel ports of the **VP-88ETH** units
  - If shielded twisted pair cable is used, the shield may be connected to the “G” (Ground) PIN on one of the units (for example, on the **RC-3000**)

---

1 Previously known as VS-3000

2 Switch OFF the power on each device before connecting it to your VP-88ETH. After connecting your VP-88ETH, switch on its power and then switch on the power on each device

3 Refer to the RC-3000 user manual for details of how to terminate the RS-485 line

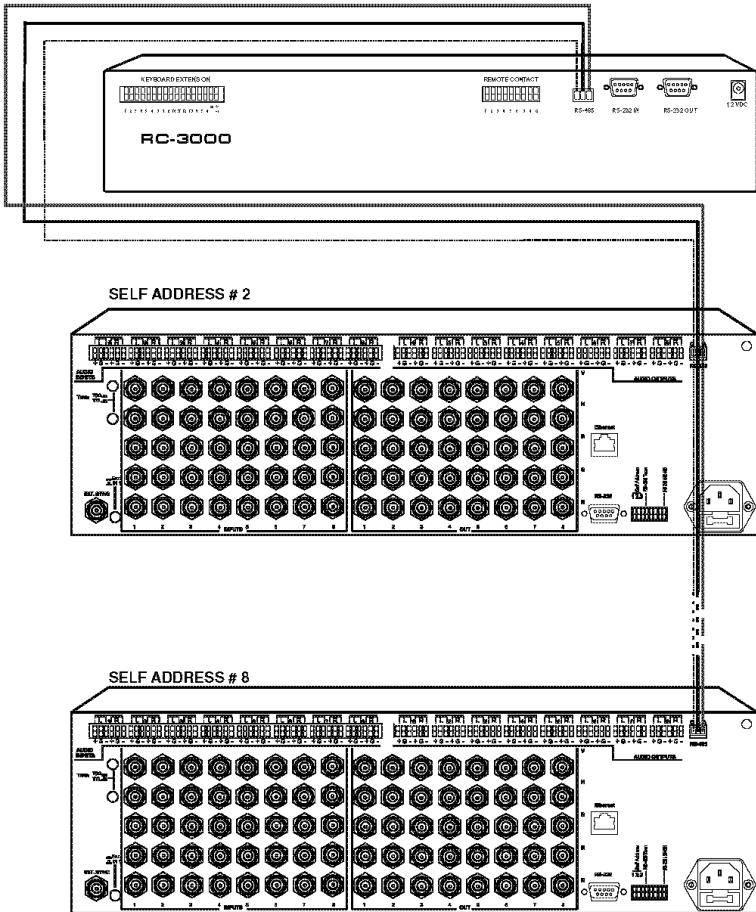

Figure 33: Control Configuration via RS-485

### 7.3 Control Configuration via the ETHERNET Port

To control several units via the ETHERNET, connect the Master unit (SELF ADDRESS # 1) via the ETHERNET port to the LAN port of your PC. Using your PC, initially configure the settings as described in section 5.4.

## 8 Technical Specifications

Table 9 includes the technical specifications:

Table 9: Technical Specifications<sup>1</sup> of the RGBH / Balanced Audio Matrix Switchers

INPUTS:	<b>VP-88ETH, VP-84ETH and VP82-ETH:</b> 8x3 video (RGB): 0.7 Vpp/75ohm, on BNCs; 1 Sync/Video Genlock with sync select switch 1 Vpp/75ohm on a BNC; 8x2 Hs & Vs, TTL level/510 ohm or Video 0.7 Vpp/75ohm, on BNCs; 8 balanced stereo audio, +4dBm/33kohm, on detachable terminal blocks <b>VP-66ETH and VP-64ETH:</b> 6x3 video (RGB): 0.7 Vpp/75ohm, on BNCs; 1 Sync/Video Genlock with sync select switch 1 Vpp/75ohm on a BNC; 6x2 Hs & Vs, TTL level/510 ohm or Video 0.7 Vpp/75ohm, on BNCs; 86 balanced stereo audio, +4dBm/33kohm, on detachable terminal blocks	
OUTPUTS:	<b>VP-88ETH:</b> 8x3 video (RGB): 0.7 Vpp/75ohm, on BNCs; 8x2 Hs & Vs, TTL level/510 ohm or Video 0.7 Vpp/75ohm, on BNCs; 8 balanced stereo audio, +4dBm/150ohm, on detachable terminal blocks <b>VP-66ETH:</b> 6x3 video (RGB): 0.7 Vpp/75ohm, on BNCs; 6x2 Hs & Vs, TTL level/510 ohm or Video 0.7 Vpp/75ohm, on BNCs; 6 balanced stereo audio, +4dBm/150ohm, on detachable terminal blocks <b>VP-84ETH and VP-64ETH:</b> 4x3 video (RGB): 0.7 Vpp/75ohm, on BNCs; 4x2 Hs & Vs, TTL level/510 ohm or Video 0.7 Vpp/75ohm, on BNCs; 4 balanced stereo audio, +4dBm/150ohm, on detachable terminal blocks <b>VP-82ETH:</b> 2x3 video (RGB): 0.7 Vpp/75ohm, on BNCs; 2x2 Hs & Vs, TTL level/510 ohm or Video 0.7 Vpp/75ohm, on BNCs; 2 balanced stereo audio, +4dBm/150ohm, on detachable terminal blocks	
MAX. OUTPUT LEVEL:	VIDEO: 0.7 Vpp (RGB)	AUDIO: +4dBm/150ohm (24Vpp max.)
BANDWIDTH (-3dB):	VIDEO: 300MHz, Fully Loaded	AUDIO: 100kHz
S/N RATIO:	VIDEO: 74dB	AUDIO: 84dB unweighted, (1Vpp)
CROSSTALK (all hostile):	VIDEO: <-50dB @ 5MHz	
CONTROLS:	Manual, RS-232, RS-485 or ETHERNET	
AUDIO THD:	0.025% (1V, 1kHz)	
POWER SOURCE:	100 - 240VAC, 50 / 60 Hz, 23VA	
DIMENSIONS:	19" x 7" x 3U	
WEIGHT:	5.5kg (12.2lbs) approx.	
ACCESSORIES:	Power cord, Windows®-based Configuration Manager XPort software and Com Port Redirector, Windows®-based Kramer control software, Null-modem adapter	

<sup>1</sup> Specifications are subject to change without notice



## 9 Table of Hex Codes for the Master VP-88ETH

Table 10 shows the “HEX” codes for switching the master **VP-88ETH**.

*Table 10: Hex Codes for Switching the Master VP-88ETH*

OUT	1	2	3	4	5	6	7	8
IN 1	01	01	01	01	01	01	01	01
	81	81	81	81	81	81	81	81
	81	82	83	84	85	86	87	88
	81	81	81	81	81	81	81	81
IN 2	01	01	01	01	01	01	01	01
	82	82	82	82	82	82	82	82
	81	82	83	84	85	86	87	88
	81	81	81	81	81	81	81	81
IN 3	01	01	01	01	01	01	01	01
	83	83	83	83	83	83	83	83
	81	82	83	84	85	86	87	88
	81	81	81	81	81	81	81	81
IN 4	01	01	01	01	01	01	01	01
	84	84	84	84	84	84	84	84
	81	82	83	84	85	86	87	88
	81	81	81	81	81	81	81	81
IN 5	01	01	01	01	01	01	01	01
	85	85	85	85	85	85	85	85
	81	82	83	84	85	86	87	88
	81	81	81	81	81	81	81	81
IN 6	01	01	01	01	01	01	01	01
	86	86	86	86	86	86	86	86
	81	82	83	84	81	82	83	84
	81	81	81	81	81	81	81	81
IN 7	01	01	01	01	01	01	01	01
	87	87	87	87	87	87	87	87
	81	82	83	84	85	86	87	88
	81	81	81	81	81	81	81	81
IN 8	01	01	01	01	01	01	01	01
	88	88	88	88	88	88	88	88
	81	82	83	84	85	86	87	88
	81	81	81	81	81	81	81	81

## 10 Communication Protocol

Communication with the **VP-88ETH** uses four bytes of information as defined below. Data is transferred at 9600 baud with no parity, 8 data bits and 1 stop bit.

Table 11: Protocol Definitions

MSB								LSB
		DESTINATION	INSTRUCTION					
0	D	N5	N4	N3	N2	N1	N0	
7	6	5	4	3	2	1	0	
1st byte								
		INPUT						
1	0	0	0	I3				
7	6	5	4	3				
2nd byte								
		OUTPUT						
1	0	0	0	O3				
7	6	5	4	3				
3rd byte								
		MACHINE NUMBER						
1	0	0	0	0	M2	M1		
7	6	5	4	3	2	1		
4th byte								

**1<sup>st</sup> BYTE:** Bit 7 – Defined as "0",

D – "DESTINATION BIT"

This bit is always "low", when sending from the PC to the Matrix Switchers, and "high" for information sent to the PC.

**N5...N0 – "INSTRUCTION".**

The function that is to be performed by the Matrix Switcher (s) is defined by these 6 bits. Similarly, if a function is performed via the machine's keyboard, then these bits are set with the **INSTRUCTION #** which was performed. The instruction codes are defined according to the table below (**INSTRUCTION #** is the value to be set for N5...N0).

**2<sup>nd</sup> BYTE:** Bit 7 – Defined as "1",

Bits 4 – 6 - Defined as "0".

I3... I0 – "INPUT".

When switching via RS-232 for RS-485 (for instruction codes 1 and 2), these bits set the input that is to be switched. Similarly, if switching is done via the machine's keyboard, then these bits are set with the input number which was switched. For disconnect, set as 0. For other operations, these bits are defined according to the table.

**3<sup>rd</sup> BYTE:** Bit 7 - Defined as "1",

Bits 4-6 Defined as "0".

O3 – O0 – "OUTPUT".

When switching via RS-232 or RS-485 (for instruction codes 1 and 2), the output to switch is set by these bits. Similarly, if switching is done via the machine's keyboard, then these bits are set with the output number that was switched. For other operations, these bits are defined according to the table.

**4th BYTE:** Bit 7 – Defined as "1",

Bits 3-6 Defined as "0".

M2... M0 – "Machine Number".

Machine Number = (DIP – Switch Code) + 1.

## Communication Protocol

INSTRUCTION		DEFINITION FOR SPECIFIC INSTRUCTION		NOTE
#	DESCRIPTION	INPUT	OUTPUT	
0	RESET MACHINE	0	0	1
1	SWITCH VIDEO	Set equal to video input to be switched	Set equal to video output to be switched (0=to all the outputs)	2
2	SWITCH AUDIO	Set equal to audio input to be switched	Set equal to audio output to be switched (0=to all the outputs)	2
3	STORE STATUS	Set as SETUP #(1-8)	- To store parameters - to delete setup	2,7
4	RECALL STATUS	Set as SETUP #(1-8)	Don't care	2,7
5	REQUEST STATUS OF A VIDEO OUTPUT	Set as SETUP #(1-8)	Equal to output number whose status is read	3,7
6	REQUEST STATUS OF AN AUDIO OUTPUT	Set as SETUP #(1-8)	Equal to output number whose status is read	3,7
7	VIS SETTING	Don't care	- for immediate switching - for VIS switching	2
8	BREAKAWAY SETTING	Don't care	- for audio-follow-video - for breakaway	2
9	NOT USED			
10	REQUEST VIS SETTING	Set as SETUP #(1-8)	Don't care	3,7
11	REQUEST BREAKAWAY SETTING	Set as SETUP #(1-8)	Don't care	3,7
12 to 14	NOT USED			
15	REQUEST WHETHER SETUP IS DEFINED	Set as SETUP #(1-8)	Don't care	4
16	ERROR/BUSY	Don't care	Don't care	5
17	RESERVED			6
18	RESET MACHINE	0	0	1
19	STORE STATUS	Set as SETUP #(1-8)	0-to store parameters 1-to delete setup	2,7,9
20	RECALL STATUS	Set as SETUP #(1-8)	Don't care	2,7,10
21 to 56	NOT USED			
57	SET AUTO-SAVE	for auto save 0 – no save	Don't care	8,2
58 to 60	RESERVED			
61	IDENTIFY MACHINE	1 or 2 – machine name 3 or 4 – version	Don't care	11

NOTES on the above table:

**NOTE 1** - When the master switcher is reset, (e.g. when it is turned on), the reset code is sent to the PC. If this code is sent to the switchers, it will reset according to the present power-down settings.

**NOTE 2** - These are bi-directional definitions. That is, if the switcher receives the code, it performs the instruction, and if the instruction is performed (due to a keystroke on the front panel), then these codes are sent. For example:

```
0000 0001
1000 0101
1000 1000
0011
```

was sent from the PC, then the switcher (machine#3) will switch input 5 to output 8. If the user switched input#1 to output#7 via the front panel keypad, then the switcher will send:

```
0100 0001
1000 0001
1000 0111
1000 0011    => to the PC.
```

When the PC sends one of the commands in this group to the switcher, then, if the instruction is valid, the switcher replies by sending to the PC the same four bytes that it sent (except for the first byte, where the DESTINATION bit is set "high").

**NOTE 3** - The reply to a "REQUEST" instruction is as follows: the same instruction and INPUT codes as were sent are returned, and the OUTPUT is assigned the value of the requested parameter. The replies to instructions 10 and 11 are as per the definitions in instructions 7 and 8 respectively. For example, if the present status of machine number#5 is breakaway setting, then the reply to

0000 1011		0100 1100
1000 0001	Would be ⇒	1000 0001
1000 0000		1000 0001
1000 0101		1000 0101

**NOTE 4** - The reply to the "REQUEST WHETHER SETUP IS DEFINED" is as in TYPE 3 above, except that here the OUTPUT is assigned with the value 0 if the setup is not defined; or 1 if it is defined.

**NOTE 5** - An error code is returned to the PC if an invalid code was sent to the switcher (e.g. trying to save to a setup greater than 8, or trying to switch an input or output greater than the highest one defined). This code is also returned to the PC if an RS-232 instruction is sent while the machine is being programmed via the front panel. Reception of this code by the switcher is not valid.

**NOTE 6** - This code is reserved for internal use.

**NOTE 7** - SETUP #0 is the present setting. SETUP #1 to SETU P#8 are the settings saved in the switcher's memory, (i.e. those used for Store and Recall).

**NOTE 8** - Under normal conditions, the machine's present status is saved each time a change is made. The "power-down" save (auto-save) may be disabled using this code. Note that whenever the machine is turned on, auto-save function is set.

**NOTE 9** - This is identical to instruction 3 (machine uses instruction 3, when sending to PC).

**NOTE 10** - This is identical to instruction 4 (machine uses instruction 4, when sending to PC).

**NOTE 11** - This is a request to identify the switcher/s in the system. If the INPUT is set as 1 or 2, the machine will send its name. The reply is the decimal value of the INPUT and OUTPUT. For example, the reply to the request to send machine name (for machine number 001) would be:

0111 1101	
1000 1000	(i.e. 128 + 8)
1000 1000	(i.e. 128 + 8)
1000 0001	

If the request for identification is sent with the INPUT set as 3 or 4, the appropriate machine will send its software version number. Again, the reply would be the decimal value of the INPUT and OUTPUT - the INPUT representing the number in front of the decimal point, and the OUTPUT representing the number after it.

For example, for version 3.5, the reply would be:

0111 1101	
1000 0011	(i.e. 128 + 3)
1000 0101	(i.e. 128 + 5)
1000 0001	



---

## LIMITED WARRANTY

Kramer Electronics (hereafter *Kramer*) warrants this product free from defects in material and workmanship under the following terms.

### HOW LONG IS THE WARRANTY

Labor and parts are warranted for seven years from the date of the first customer purchase.

### WHO IS PROTECTED?

Only the first purchase customer may enforce this warranty.

### WHAT IS COVERED AND WHAT IS NOT COVERED

Except as below, this warranty covers all defects in material or workmanship in this product. The following are not covered by the warranty:

1. Any product which is not distributed by Kramer, or which is not purchased from an authorized Kramer dealer. If you are uncertain as to whether a dealer is authorized, please contact Kramer at one of the agents listed in the Web site [www.kramerelectronics.com](http://www.kramerelectronics.com).
2. Any product, on which the serial number has been defaced, modified or removed.
3. Damage, deterioration or malfunction resulting from:
  - i) Accident, misuse, abuse, neglect, fire, water, lightning or other acts of nature
  - ii) Product modification, or failure to follow instructions supplied with the product
  - iii) Repair or attempted repair by anyone not authorized by Kramer
  - iv) Any shipment of the product (claims must be presented to the carrier)
  - v) Removal or installation of the product
  - vi) Any other cause, which does not relate to a product defect
  - vii) Cartons, equipment enclosures, cables or accessories used in conjunction with the product

### WHAT WE WILL PAY FOR AND WHAT WE WILL NOT PAY FOR

We will pay labor and material expenses for covered items. We will not pay for the following:

1. Removal or installations charges.
2. Costs of initial technical adjustments (set-up), including adjustment of user controls or programming. These costs are the responsibility of the Kramer dealer from whom the product was purchased.
3. Shipping charges.

### HOW YOU CAN GET WARRANTY SERVICE

1. To obtain service on you product, you must take or ship it prepaid to any authorized Kramer service center.
2. Whenever warranty service is required, the original dated invoice (or a copy) must be presented as proof of warranty coverage, and should be included in any shipment of the product. Please also include in any mailing a contact name, company, address, and a description of the problem(s).
3. For the name of the nearest Kramer authorized service center, consult your authorized dealer.

### LIMITATION OF IMPLIED WARRANTIES

All implied warranties, including warranties of merchantability and fitness for a particular purpose, are limited in duration to the length of this warranty.

### EXCLUSION OF DAMAGES

The liability of Kramer for any effective products is limited to the repair or replacement of the product at our option. Kramer shall not be liable for:

1. Damage to other property caused by defects in this product, damages based upon inconvenience, loss of use of the product, loss of time, commercial loss; or
2. Any other damages, whether incidental, consequential or otherwise. Some countries may not allow limitations on how long an implied warranty lasts and/or do not allow the exclusion or limitation of incidental or consequential damages, so the above limitations and exclusions may not apply to you.

This warranty gives you specific legal rights, and you may also have other rights, which vary from place to place.

**NOTE:** All products returned to Kramer for service must have prior approval. This may be obtained from your dealer.

This equipment has been tested to determine compliance with the requirements of:

- EN-50081: "Electromagnetic compatibility (EMC);  
generic emission standard.  
Part 1: Residential, commercial and light industry"
- EN-50082: "Electromagnetic compatibility (EMC) generic immunity standard.  
Part 1: Residential, commercial and light industry environment".
- CFR-47:  
FCC Rules and Regulations:  
Part 15: "Radio frequency devices  
Subpart B – Unintentional radiators"

### CAUTION!

- ☒ Servicing the machines can only be done by an authorized Kramer technician. Any user who makes changes or modifications to the unit without the expressed approval of the manufacturer will void user authority to operate the equipment.
- ☒ Use the supplied DC power supply to feed power to the machine.
- ☒ Please use recommended interconnection cables to connect the machine to other components.



---

For the latest information on our products and a list of Kramer distributors, visit our Web site: [www.kramerelectronics.com](http://www.kramerelectronics.com), where updates to this user manual may be found. We welcome your questions, comments and feedback.

 <p><b>Caution</b></p>	<p><b><u>Safety Warning</u></b> Disconnect the unit from the power supply before opening/servicing.</p>
---	---



---

**Kramer Electronics, Ltd.**  
Web site: [www.kramerelectronics.com](http://www.kramerelectronics.com)  
E-mail: [info@kramerel.com](mailto:info@kramerel.com)  
P/N: 2900-002093 REV 2