

Kramer Electronics, Ltd.

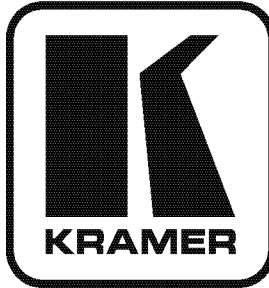

USER MANUAL

Models:

PT-102AN, 1:2 Audio DA

PT-102SN, 1:2 s-Video DA

Contents

| | | |
|----------|--|----------|
| 1 | Introduction | 1 |
| 2 | Getting Started | 1 |
| 2.1 | Quick Start | 1 |
| 3 | Overview | 3 |
| 3.1 | About the PT102AN 1:2 Audio DA | 3 |
| 3.2 | About the PT-102SN 1:2 s-Video DA | 3 |
| 4 | Your 1:2 Distribution Amplifier | 4 |
| 4.1 | Your PT-102AN 1:2 Audio DA | 4 |
| 4.2 | Your PT-102SN 1:2 s-Video DA | 5 |
| 5 | Connecting the 1:2 Distribution Amplifier | 5 |
| 5.1 | Connecting the PT-102AN 1:2 Audio DA | 6 |
| 5.2 | Connecting the PT-102SN 1:2 s-Video DA | 7 |
| 5.3 | Increasing the Number of Inputs/Outputs | 8 |
| 6 | Technical Specifications | 9 |

Figures

| | | |
|-----------|--|---|
| Figure 1: | PT-102AN 1:2 Audio DA | 4 |
| Figure 2: | PT-102SN 1:2 s-Video DA | 5 |
| Figure 3: | Connecting the PT-102AN 1:2 Audio DA | 6 |
| Figure 4: | Connecting the PT-102SN 1:2 s-Video DA | 7 |
| Figure 5: | Increasing the Inputs | 8 |
| Figure 6: | Increasing the Outputs | 8 |

Tables

| | | |
|----------|---|---|
| Table 1: | Features and Functions of the PT-102AN 1:2 Audio DA | 4 |
| Table 2: | Features and Functions of the PT-102SN 1:2 s-Video DA | 5 |
| Table 3: | Technical Specifications of the PT-102AN / PT-102SN | 9 |

1 Introduction

Welcome to Kramer Electronics! Since 1981, Kramer Electronics has been providing a world of unique, creative, and affordable solutions to the vast range of problems that confront the video, audio, presentation, and broadcasting professional on a daily basis. In recent years, we have redesigned and upgraded most of our line, making the best even better! Our 1,000-plus different models now appear in 11 groups¹ that are clearly defined by function.

Congratulations on purchasing your Kramer **PT-102AN** *1:2 Audio DA*, and/or **PT-102SN** *1:2 s-Video DA* which are ideal for:

- Audio/video duplication studios
- Retail showrooms, home theater systems
- CCTV and security systems

Each package includes the following items:

- *1:2 DA (PT-102AN or PT-102SN)*
- Power adapter (12V DC Input) and mounting bracket
- This user manual²

2 Getting Started

We recommend that you:

- Unpack the equipment carefully and save the original box and packaging materials for possible future shipment
- Review the contents of this user manual
- Use Kramer high performance high resolution cables³

2.1 Quick Start

This quick start chart summarizes the basic setup and operation steps.

1 GROUP 1: Distribution Amplifiers; GROUP 2: Switchers and Matrix Switchers; GROUP 3: Control Systems; GROUP 4: Format/Standards Converters; GROUP 5: Range Extenders and Repeaters; GROUP 6: Specialty AV Products; GROUP 7: Scan Converters and Scalers; GROUP 8: Cables and Connectors; GROUP 9: Room Connectivity; GROUP 10: Accessories and Rack Adapters; GROUP 11: Sierra Products

2 Download up-to-date Kramer user manuals from our Web site at <http://www.kramerelectronics.com>

3 The complete list of Kramer cables is on our Web site at <http://www.kramerelectronics.com>

Step 1: Connect the 1:2 DA

Quick Start: PT-102AN, PT-102SN

- 1 Connect the audio input.
- 2 Connect the audio outputs.

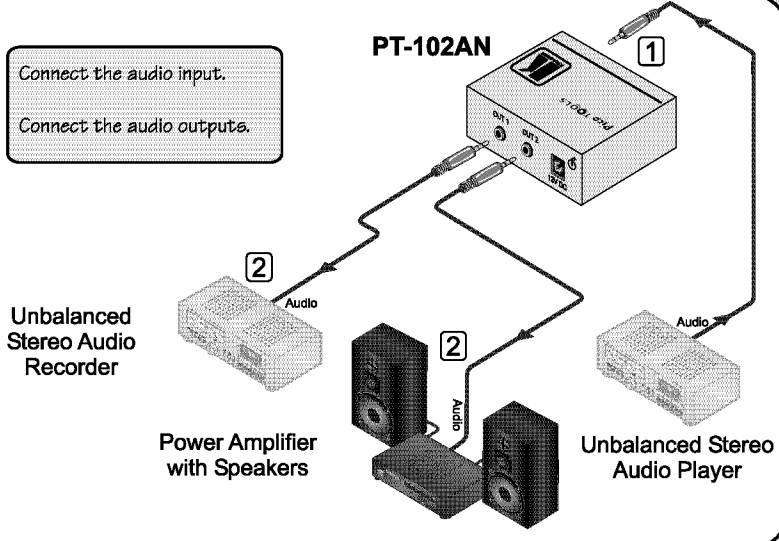

- 1 Connect the s-Video input.
- 2 Connect the s-Video outputs.

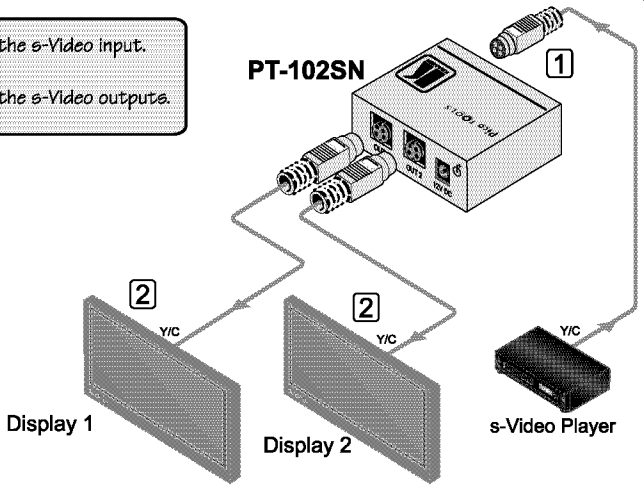

Step 2: Connect the power

If required:

- Adjust the levels



3 Overview

The Pico TOOLS micro-sized high performance 1:2 distribution amplifiers that are described in this user manual include the following:

- **PT-102AN**, see section 3.1
- **PT-102SN**, see section 3.2

3.1 About the **PT102AN 1:2 Audio DA**

The **PT-102AN 1:2 Audio DA** is a micro-sized high performance 1:2 distribution amplifier for unbalanced¹ stereo audio signals.

The **PT-102AN**:

- Accepts a single unbalanced stereo audio input and distributes it to two identical outputs using 3.5mm mini connectors
- Has separate left and right gain controls for optimizing signal levels
- Is ideally suited to work with the Pico TOOLS **PT-102VN 1:2 Video DA** and the Pico TOOLS **PT-102SN 1:2 s-Video DA**

3.2 About the **PT-102SN 1:2 s-Video DA**

The **PT-102SN 1:2 s-Video DA** is a micro-sized high performance 1:2 distribution amplifier for s-Video (Y/C) signals.

The **PT-102SN**:

- Accepts a single s-Video input and distributes it to two identical outputs via 4-pin connectors
- Has a bandwidth of 150MHz, ensuring that it remains transparent even in the most critical applications
- Has separate chrominance and luminance gain controls
- Is ideally suited to work with the Pico TOOLS **PT-102AN 1:2 Audio DA**

To achieve the best performance:

- Connect only good quality connection cables, thus avoiding interference, deterioration in signal quality due to poor matching, and elevated noise levels (often associated with low quality cables)
- Avoid interference from neighboring electrical appliances that may adversely influence signal quality and position your Kramer **PT-102AN / PT-102SN** machine away from moisture, excessive sunlight and dust

¹ You can use the PT-102AN to distribute a balanced mono audio signal, via readily available adapter cables



Caution – No operator-serviceable parts inside unit.

Warning – Use only the Kramer Electronics input power wall adapter that is provided with this unit¹.

Warning – Disconnect power and unplug unit from wall before installing or removing device or servicing unit.

4 Your 1:2 Distribution Amplifier

This section defines the:

- **PT-102AN**, see section 4.1
- **PT-102SN**, see section 4.2

4.1 Your PT-102AN 1:2 Audio DA

Figure 1 and Table 1 define the **PT-102AN 1:2 Audio DA**:

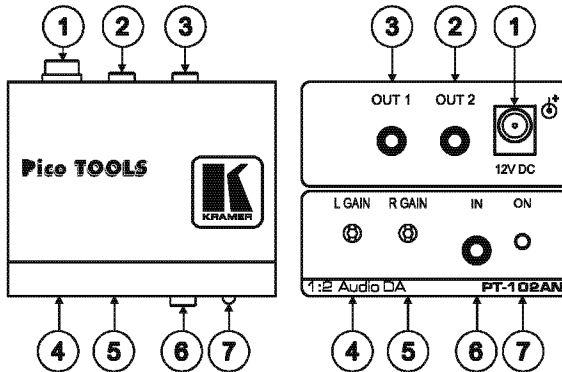

Figure 1: PT-102AN 1:2 Audio DA

Table 1: Features and Functions of the PT-102AN 1:2 Audio DA

| # | Feature | Function |
|---|----------------------------|--|
| 1 | 12V DC | +12V DC connector for powering the unit |
| 2 | OUT 2 3.5mm Mini Connector | Connects to stereo audio acceptor 2 |
| 3 | OUT 1 3.5mm Mini Connector | Connects to stereo audio acceptor 1 |
| 4 | L GAIN Trimmer | Adjusts ² the output level of the left audio channel |
| 5 | R GAIN Trimmer | Adjusts ² the output level of the right audio channel |
| 6 | IN 3.5mm Mini Connector | Connects to the stereo audio source |
| 7 | ON LED | Illuminates when receiving power |

¹ For example: model number AD2512C, part number 2535-000251

² Insert a screwdriver into the hole and carefully rotate it, to trim the level

4.2 Your PT-102SN 1:2 s-Video DA

Figure 2 and Table 2 define the **PT-102SN 1:2 s-Video DA**:

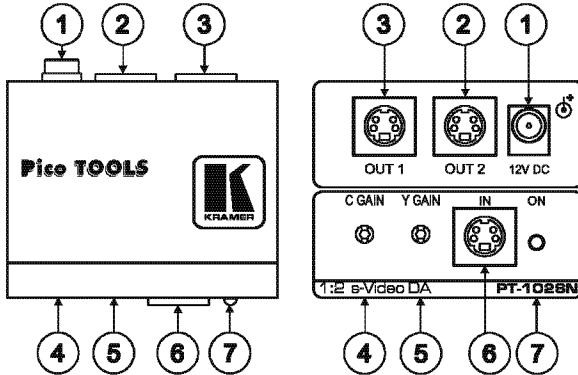

Figure 2: PT-102SN 1:2 s-Video DA

Table 2: Features and Functions of the PT-102SN 1:2 s-Video DA

| # | Feature | Function |
|---|-----------------------|--|
| 1 | 12V DC | +12V DC connector for powering the unit |
| 2 | OUT 2 4-pin Connector | Connects to s-Video acceptor 2 |
| 3 | OUT 1 4-pin Connector | Connects to s-Video acceptor 1 |
| 4 | C GAIN Trimmer | Adjusts ¹ the chroma (chrominance) output level |
| 5 | Y GAIN Trimmer | Adjusts ¹ the luma (luminance) output level |
| 6 | IN 4-pin Connector | Connects to the s-Video source |
| 7 | ON LED | Illuminates when receiving power |

5 Connecting the 1:2 Distribution Amplifier

This section describes how to connect:

- The **PT-102AN**, see section 5.1
- The **PT-102SN**, see section 5.2
- Additional inputs or outputs, see section 5.3

¹ Insert a screwdriver into the hole and carefully rotate it, to trim the level

5.1 Connecting the PT-102AN 1:2 Audio DA

To connect the **PT-102AN 1:2 Audio DA**, as the example in Figure 3 illustrates, connect the following¹:

1. Connect an unbalanced stereo audio source (for example, an unbalanced stereo audio player) to the IN 3.5mm mini connector.
2. Connect the two OUT 3.5mm mini connectors to up to two unbalanced stereo audio acceptors, as follows:
 - Connect the OUT 1 connector to an unbalanced audio acceptor (for example, an unbalanced stereo audio recorder)
 - Connect the OUT 2 connector to an unbalanced audio acceptor (for example, a power amplifier with speakers)
3. Connect the 12V DC power adapter to the power socket and connect the adapter to the mains electricity.
4. Adjust the left and right gain level, if required.

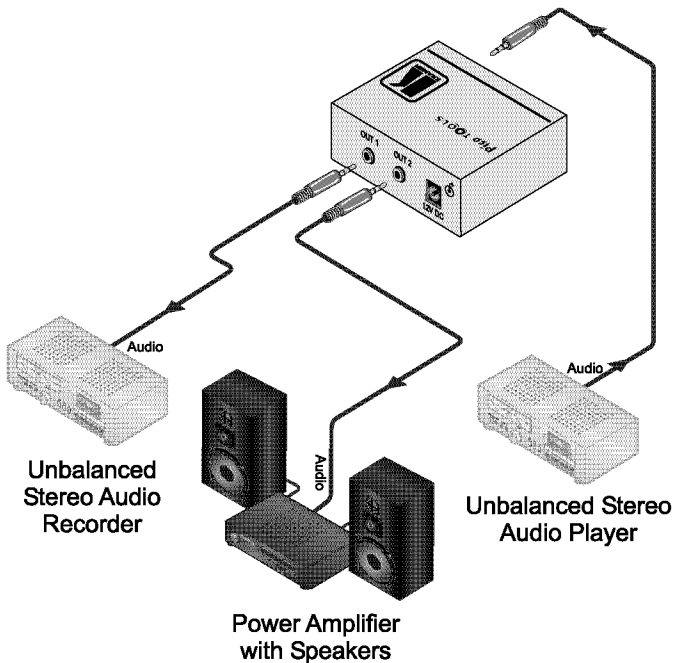

Figure 3: Connecting the PT-102AN 1:2 Audio DA

¹ Switch OFF the power on each device before connecting it to your PT-102AN. After connecting your PT-102AN, switch on its power and then switch on the power on each device

5.2 Connecting the PT-102SN 1:2 s-Video DA

To connect the **PT-102SN 1:2 Audio DA**, as the example in Figure 4 illustrates, connect the following¹:

1. Connect an s-Video source to the IN 4-pin connector (for example, an s-Video player).
2. Connect the two OUT 4-pin connectors to up to two s-video acceptors (for example, displays).
3. Connect the 12V DC power adapter to the power socket and connect the adapter to the mains electricity.
4. Adjust the C and Y gain level, if required.

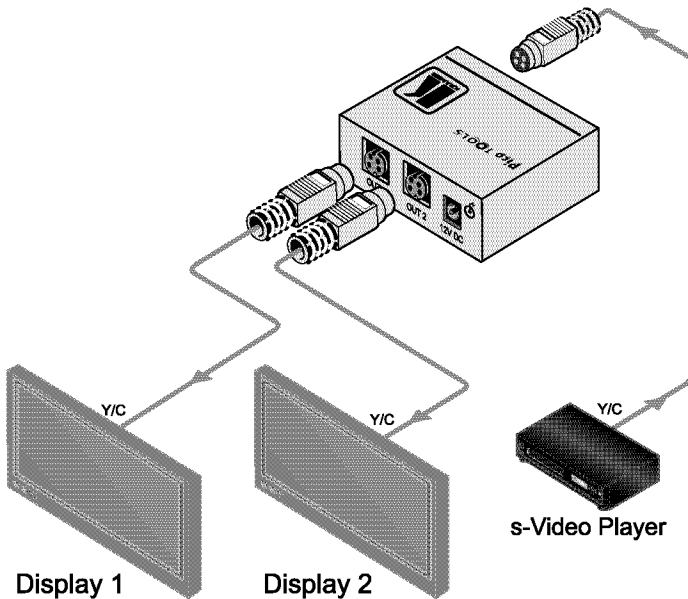

Figure 4: Connecting the PT-102SN 1:2 s-Video DA

¹ Switch OFF the power on each device before connecting it to your PT-102SN. After connecting your PT-102SN, switch on its power and then switch on the power on each device

5.3 Increasing the Number of Inputs/Outputs

When it is necessary to handle more than one input (that is, to be able to select one of several inputs), you can increase the number of inputs by connecting the output of another switcher to the input of the machine (for example, connect the output of the **Kramer 4x1S 4x1 s-Video Mechanical Switcher**¹ to the input of the **PT-102SN**, to create a 4x2 switcher, as illustrated in Figure 5).

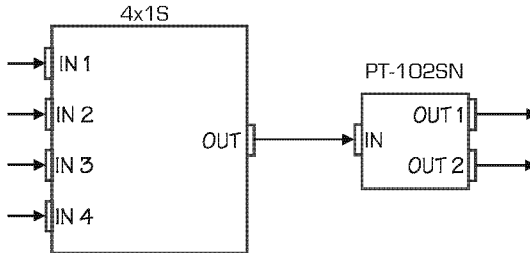

Figure 5: Increasing the Inputs

You can cascade the unit with other high quality distribution amplifiers to distribute a source to more than two outputs (for example, connect each of the outputs of the **PT-102AN** to the input of the **Kramer 105A 1:5 Stereo Audio Distribution Amplifier**¹, to create a 1:10 DA, as illustrated in Figure 6).

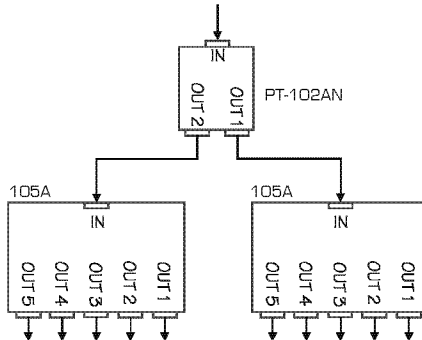

Figure 6: Increasing the Outputs

¹ Refer to the separate user manual, which can be downloaded at <http://www.kramerelectronics.com>

6 Technical Specifications

Table 3 includes the technical specifications:

Table 3: Technical Specifications¹ of the PT-102AN / PT-102SN

| | PT-102AN | PT-102SN |
|---------------------------------|---|--|
| INPUTS: | 1 unbalanced stereo audio on a 3.5mm mini plug connector | 1 s-Video on a 4-pin connector |
| OUTPUTS: | 2 unbalanced stereo audio on 3.5mm mini plug connectors | 2 s-Video on 4-pin connectors |
| MAX. OUTPUT LEVEL: | 5Vpp | 1.3Vpp |
| BANDWIDTH (-3dB): | >100kHz | 150MHz |
| DIFF. GAIN: | - | 0.05% |
| DIFF. PHASE: | - | 0.05 Deg |
| K-FACTOR: | - | <0.05% |
| S/N RATIO: | 85dB @1kHz | 76dB @5MHz |
| CONTROLS: | Level: -55dB to +20dB | Gain: luma: -1.9dB to +5.1dB chroma: 0dB to +6.8dB, @5MHz |
| COUPLING: | AC | AC |
| AUDIO THD + NOISE: | 0.01% @1kHz | - |
| AUDIO 2 nd HARMONIC: | 0.004% @1kHz | - |
| POWER SOURCE: | 12V DC, 20mA | 12V DC, 25mA |
| DIMENSIONS: | 6.22cm x 5.18cm x 2.44cm (2.45" x 2.04" x 0.96") W, D, H. | |
| WEIGHT: | 0.14kg (0.31lbs) approx. | |
| ACCESSORIES: | Power supply, mounting bracket | |
| OPTIONS: | 19" rack adapters | |

¹ Specifications are subject to change without notice

LIMITED WARRANTY

Kramer Electronics (hereafter *Kramer*) warrants this product free from defects in material and workmanship under the following terms.

HOW LONG IS THE WARRANTY

Labor and parts are warranted for seven years from the date of the first customer purchase.

WHO IS PROTECTED?

Only the first purchase customer may enforce this warranty.

WHAT IS COVERED AND WHAT IS NOT COVERED

Except as below, this warranty covers all defects in material or workmanship in this product. The following are not covered by the warranty:

1. Any product which is not distributed by Kramer, or which is not purchased from an authorized Kramer dealer. If you are uncertain as to whether a dealer is authorized, please contact Kramer at one of the agents listed in the Web site www.kramerelectronics.com.
2. Any product, on which the serial number has been defaced, modified or removed, or on which the WARRANTY VOID IF TAMPERED sticker has been torn, reattached, removed or otherwise interfered with.
3. Damage, deterioration or malfunction resulting from:
 - i) Accident, misuse, abuse, neglect, fire, water, lightning or other acts of nature
 - ii) Product modification, or failure to follow instructions supplied with the product
 - iii) Repair or attempted repair by anyone not authorized by Kramer
 - iv) Any shipment of the product (claims must be presented to the carrier)
 - v) Removal or installation of the product
 - vi) Any other cause, which does not relate to a product defect
 - vii) Cartons, equipment enclosures, cables or accessories used in conjunction with the product

WHAT WE WILL PAY FOR AND WHAT WE WILL NOT PAY FOR

We will pay labor and material expenses for covered items. We will not pay for the following:

1. Removal or installations charges.
2. Costs of initial technical adjustments (set-up), including adjustment of user controls or programming. These costs are the responsibility of the Kramer dealer from whom the product was purchased.
3. Shipping charges.

HOW YOU CAN GET WARRANTY SERVICE

1. To obtain service on your product, you must take or ship it prepaid to any authorized Kramer service center.
2. Whenever warranty service is required, the original dated invoice (or a copy) must be presented as proof of warranty coverage, and should be included in any shipment of the product. Please also include in any mailing a contact name, company, address, and a description of the problem(s).
3. For the name of the nearest Kramer authorized service center, consult your authorized dealer.

LIMITATION OF IMPLIED WARRANTIES

All implied warranties, including warranties of merchantability and fitness for a particular purpose, are limited in duration to the length of this warranty.

EXCLUSION OF DAMAGES

The liability of Kramer for any effective products is limited to the repair or replacement of the product at our option. Kramer shall not be liable for:

1. Damage to other property caused by defects in this product, damages based upon inconvenience, loss of use of the product, loss of time, commercial loss; or:
2. Any other damages, whether incidental, consequential or otherwise. Some countries may not allow limitations on how long an implied warranty lasts and/or do not allow the exclusion or limitation of incidental or consequential damages, so the above limitations and exclusions may not apply to you.

This warranty gives you specific legal rights, and you may also have other rights, which vary from place to place.

NOTE: All products returned to Kramer for service must have prior approval. This may be obtained from your dealer.

This equipment has been tested to determine compliance with the requirements of:

- EN-50081: "Electromagnetic compatibility (EMC);
generic emission standard.
Part 1: Residential, commercial and light industry"
- EN-50082: "Electromagnetic compatibility (EMC) generic immunity standard.
Part 1: Residential, commercial and light industry environment".
- CFR-47: FCC* Rules and Regulations:
Part 15: "Radio frequency devices
Subpart B Unintentional radiators"

CAUTION!

- Servicing the machines can only be done by an authorized Kramer technician. Any user who makes changes or modifications to the unit without the expressed approval of the manufacturer will void user authority to operate the equipment.
- Use the supplied DC power supply to feed power to the machine.
- Please use recommended interconnection cables to connect the machine to other components.
* FCC and CE approved using STP cable (for twisted pair products)



For the latest information on our products and a list of Kramer distributors, visit our Web site: www.kramerelectronics.com, where updates to this user manual may be found. We welcome your questions, comments and feedback.



Caution

Safety Warning:

Disconnect the unit from the power supply before opening/servicing.



Kramer Electronics, Ltd.

Web site: www.kramerelectronics.com

E-mail: info@kramerel.com

P/N: 2900-000533 REV 1